

**SEIKO**

**QUARTZ *LC***

**Cal.0139A**

**PARTS LIST**

Calibre No.

0139A

Jewels

0j

Style Name

QUARTZ LC  
DUAL-ZONE TIMER

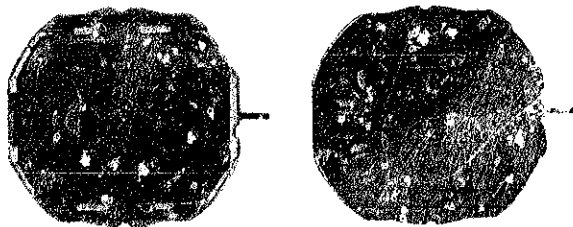

Characteristics

Casing diameter:  $\phi$ 29.20 mm  
 Maximum height: 6.41 mm  
 Frequency of quartz crystal oscillator: 32,768 Hz  
 (Hz=Hertz . . . . Cycle per second)  
 Time functions: Digital Display System showing hour, minute & second (Basic display: 12-hour indication, Zone II display: 24-hour indication)  
 Calendar functions: Digital Display System showing day of the week & date  
 Display medium: Single Crystal Display (Nematic Liquid Crystal, FE-Mode)  
 Time micro-adjustor: Trimmer condenser system  
 Illumination light for digital display panel: Illuminated in accordance with the crown depressing  
 Battery life indicator . . . . The entire display begins flashing.



283 010



353 002



354 051



383 035



389 004



637 005



687 001



735 002



981 007



4001 061

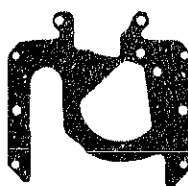

4216 028



4242 055



4242 065



4245 015



4270 015



4299 007



4313 019



4398 017

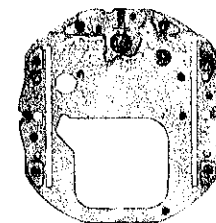

4398 028



4408 015



4450 004

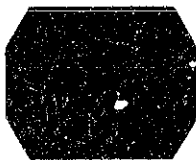

4510 301



4511 003



4521 009

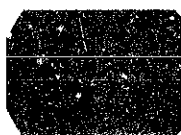

4521 011



4530 006



4532 001

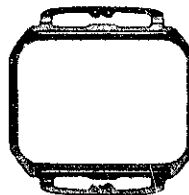

4540 002



SEIKO SB-BU

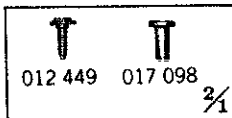

012 449 017 098

2/1

Calibre No.		Jewels	Style Name	
<b>0139A</b>		<b>0j</b>	<b>QUARTZ <i>LC</i> DUAL-ZONE TIMER</b>	
PART NO.	PART NAME	PART NO.	PART NAME	
283 010	Digit corrector wheel			
353 002	Digit corrector rocking lever spring			
354 051	Digit adjusting stem			
383 035	Setting lever			
389 004	Setting lever holder			
637 005	Stem setting spring			
687 001	Contact point lever spring			
735 002	Digit adjusting stem holder			
981 007	Digit corrector rocking lever			
4001 061	Circuit block			
4216 028	Insulator for circuit			
4242 055	Plus terminal of battery connection(A)			
4242 065	Plus terminal of battery connection(B)			
4245 015	Switch spring			
4270 013	Battery connection			
4299 007	Lower plate for switch components			
4313 019	Connector			
4398 017	Battery guard			
4398 028	Liquid crystal panel frame			
4408 015	Bulb holder			
4450 004	Switch lever			
4510 301	Liquid crystal panel			
4511 003	Filter			
4521 009	Reflecting mirror (Silver)			
4521 011	Reflecting mirror (Brown)			
4530 006	Bulb			
4532 001	Bulb holder cover			
4540 002	Spring for liquid crystal panel			
012 449	Setting lever holder screw			
012 449	Bulb holder cover screw			
012 449	Screw for plus terminal of battery connection			
012 449	Screw for battery connection			
017 098	Tube for battery connection screw			
SEIKO SB-BU	Silver oxide battery			

# TECHNICAL GUIDE

## SEIKO DIGITAL QUARTZ

CAL.0139A

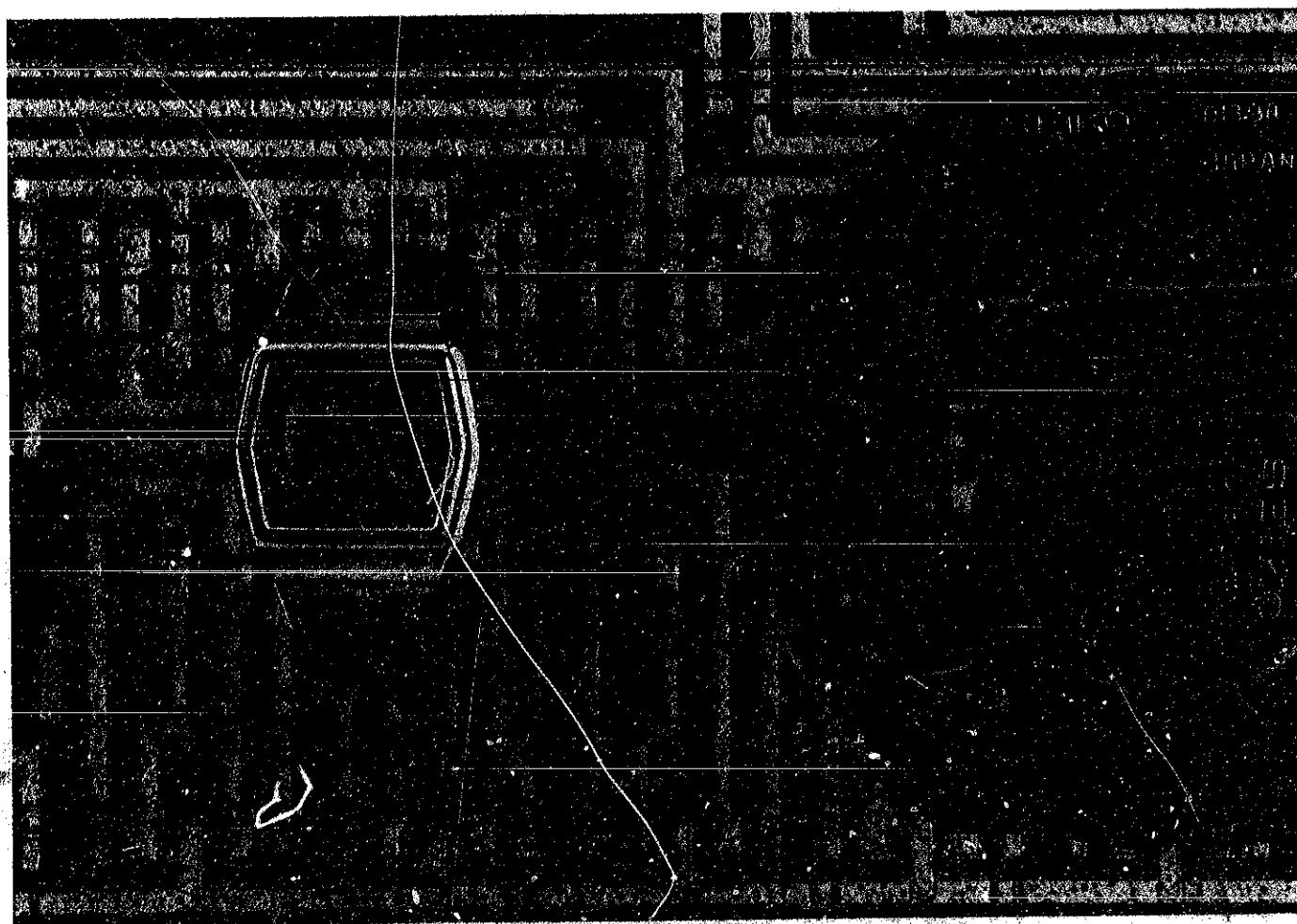

### CONTENTS

I. SPECIFICATIONS AND FEATURES .....	1
1. Specifications .....	1
2. Features .....	1
3. Display .....	2
4. Display adjustment .....	2
5. Battery life indicator .....	3
II. AFTER-SALE SERVICING INSTRUMENTS AND MATERIALS .....	4
III. DISASSEMBLING AND REASSEMBLING OF THE CASE .....	6
IV. DISASSEMBLING, REASSEMBLING, LUBRICATING AND CLEANING .....	8
1. Liquid crystal panel side .....	8
2. Switch mechanism side .....	10
3. Relation between the switch spring and the switch pin .....	12
4. Cleaning .....	13
V. CHECKING AND ADJUSTMENT .....	15
1. Guide table for checking and adjustment .....	15
2. Malfunction and checking points .....	16
3. Procedures for checking and adjustment .....	17
A: Check battery voltage .....	17
B: Check battery conductivity .....	17
C: Check conductivity of liquid crystal panel, circuit block and connector .....	17
D: Check switch components .....	18
E: Check bulb condition .....	20
F: Check circuit block .....	20
G: Check current consumption .....	21
H: Check accuracy .....	21
• Time accuracy adjusting. ....	21
I: Check functioning .....	22
J: Check battery life indicator function .....	23

I. SPECIFICATIONS AND FEATURES

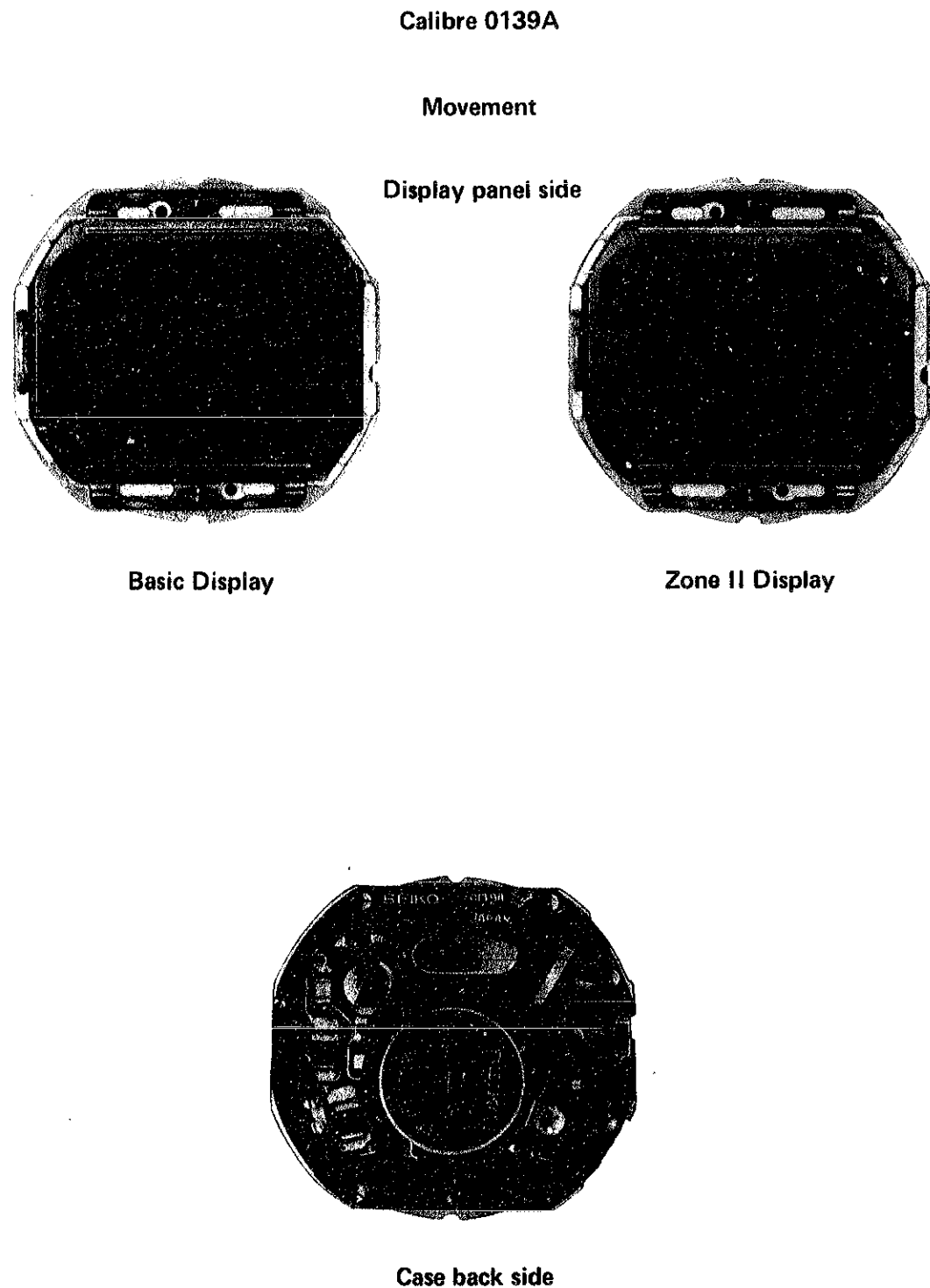

1. Specifications

Item	Calibre No.	0139A
Display medium		Single Crystal Display (Nematic Liquid Crystal, FEM (Field Effect Mode))
Display system		12-hour and 24-hour indication—adopting two-way changeover system as Dual Zone Time Hour/Minute: Basic Display . . . . . 12-hour Indication Zone II Display . . . . . 24-hour Indication (Mode can be changed by pushing in the side button.) Second: 60-second Indication Calendar function: Day of the week . . . Indicated by a moving frame Date . . . 31-day Indication (In the months with 30 days or less, an adjustment is necessary.)
Additional mechanism		Battery life indicator; Illumination light
Crystal oscillator		32,768 Hz (Hz = Hertz . . . cycle per second)
Loss/gain		Loss/gain at normal temperature range Mean monthly rate: less than 15 seconds Annual rate: less than 3 minutes
Casing diameter		φ 29.2 mm (28.5 mm between 3 o'clock and 9 o'clock side)
Height		6.4 mm
Operational temperature range		-10°C ~ +60°C (14°F ~ 140°F)
Regulation system		Trimmer condenser
Battery power		Battery life is over one year. (If the light is used ten times each day for one second at a time.) SEIKO SB-BU silver oxide battery
IC (Integrated Circuit)		C-MOS-LSI . . . 1 piece

2. Features

Cal. 0139 is a dual zone timer and the Basic Display (12-hour indication) and the Zone II Display (24-hour indication) can be changed from one to the other by simply pushing in the side button (changeover switch button). Each time and calendar display (hour, minute, date and day of the week) functions independently of each another except the second display of both functions which is the same for both the Basic Display and the Zone II Display.

### 3. Display

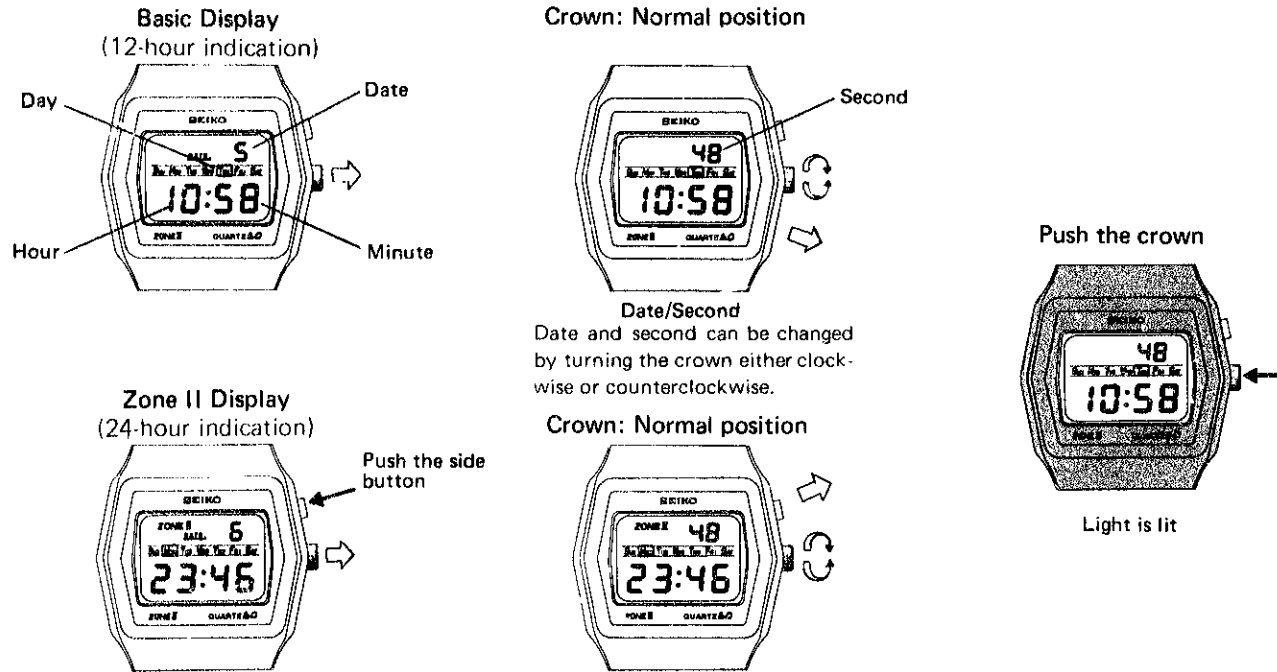

Each time and calendar display in the Basic Display and the Zone II Display can be independently adjusted except the second digits.

### 4. Display adjustment

Pull the crown out and turn it clockwise to select the digits and day indicator to be adjusted and turn it counterclockwise to adjust the digits and day indicator. Adjustment is made in the following order

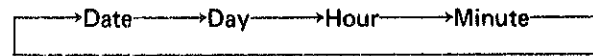

(The adjustment procedure is the same for both Basic display and Zone II display.)

Set the time shown below for example by following the procedures below.

**Example:** (In case of Basic Display)

How to change the indication of 10:45:50 AM of the 29th, Tuesday into 1:05:00 PM of the 10th, Thursday.  
Be sure to change the display in the following numerical order.  
Set the second first.

#### 1. How to set the second

With the crown pulled out to the first click and with all the displays being shown even if the date digits are displayed, the second digits are automatically displayed, depress the crown in. Then the second is reset to "00" (When the second counts any numbers from "00" to "29", the second is automatically reset to "00" and start immediately whenever the crown is depressed. If, however, the second counts from "30" to "59" when the crown is depressed, one minute is added and the seconds return to "00".

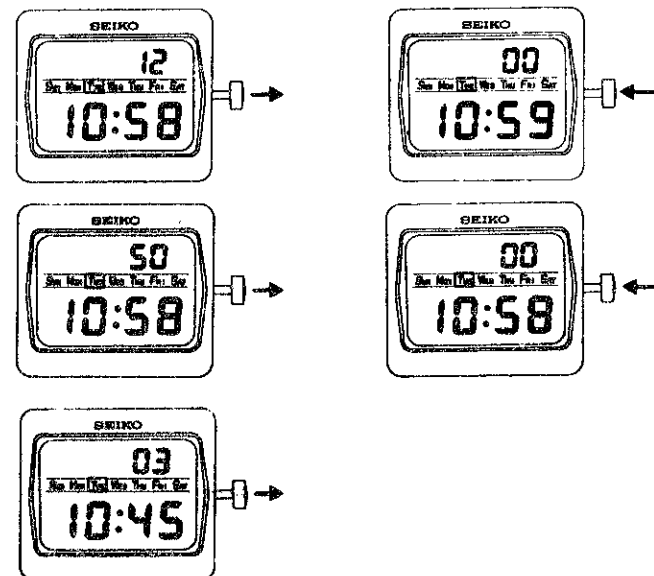

#### 2. Pull out the crown again.

### 3. How to set the date

Turn the crown clockwise, and the date digits are only displayed and other display will be extinguished. If the crown is turned counterclockwise, one date is advanced by each click.

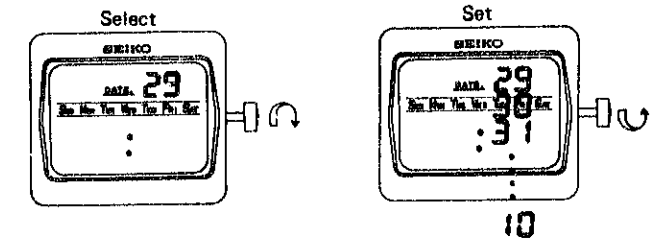

### 4. How to set the day

With the crown still in a pulled out position, turn the crown clockwise until a "click" is heard.

Then only the day of the week display "Tue" will be shown and the other displays will be extinguished. Turn the crown counterclockwise and indicator square frame of the day will advance by each click.

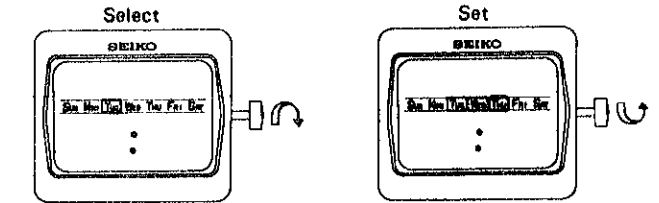

### 5. How to set the hour

With the crown still in a pulled out position, turn the crown clockwise, until a "click" is heard.

Then only the hour (10) and "A" (stands for AM) will be displayed and the other displays will be extinguished. Turn the crown counterclockwise and the hour will advance by each click.

While setting the hour, be sure to check if it is set in the A.M. or P.M. period. (If the Zone II Display (24-hour indication) is used, neither "A" (A.M.) nor "P" (P.M.) will be displayed.)

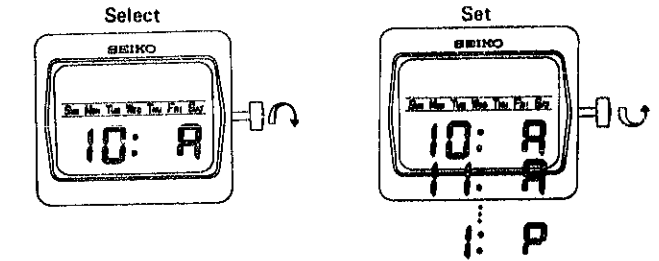

### 6. How to set the minute

With the crown still in a pulled out position, turn the crown clockwise until a "click" is heard. Then only the minute and second will be displayed and the other displays will be extinguished. Turn the crown counterclockwise and one minute will advance by each click. While setting the minute digits with above procedures, the minute digits do not advance although the second digits may pass the "59" seconds.

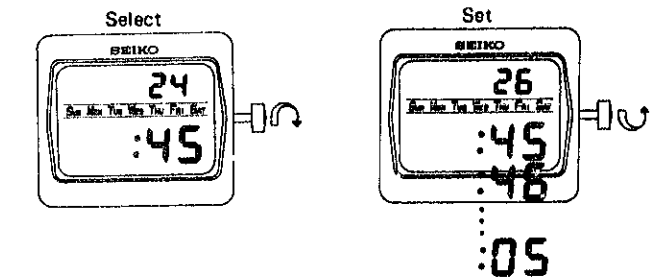

### 7. Push the crown in to the normal position.

After the time setting is completed, push the crown in to the normal position and all the displays will be indicated.

Adjustment of the Zone II Display (24-hour indication). Push the side button in to change the display to the Zone II Display and follow the above procedures 2 ~ 7. Even while adjusting the display, the Basic Display and the Zone II Display can either be changed from one to the other or be adjusted.

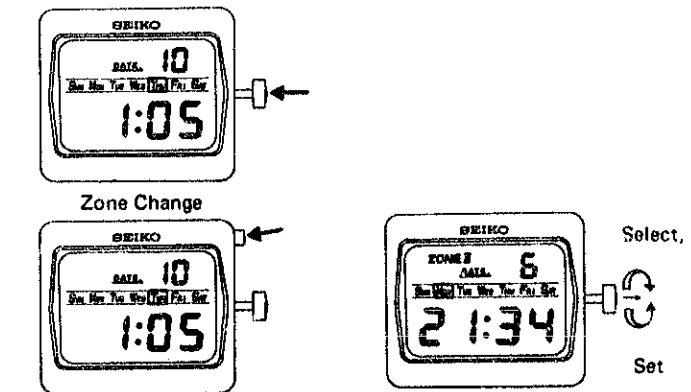

### 5. Battery life indicator

The battery needs to be replaced when you see the entire display flashing. The battery will expire in about one week from that time. The watch will, however, remain accurate while flashing.

## II. AFTER-SALE SERVICING INSTRUMENTS AND MATERIALS

For after-sale servicing of SEIKO Quartz Digital Cal. 0139A, the following after-sale servicing instruments and materials are necessary.

### 1. Quartz Tester QT-77

Used to check and adjust time accuracy.

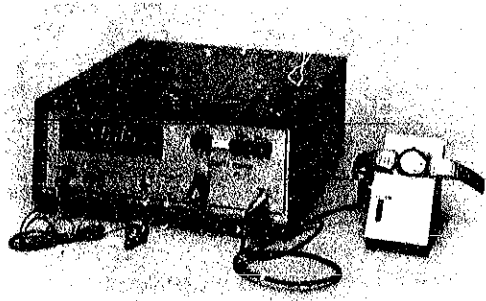

### 4. Movement holder S-644

Used for disassembling and reassembling of the movement.

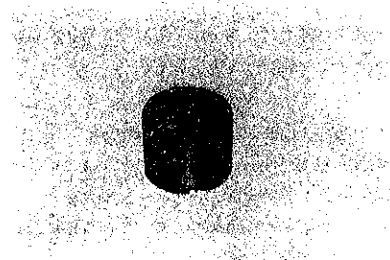

### 2. MICRO TEST MT-10 II

Used to check current consumption and to flow voltage power constantly.

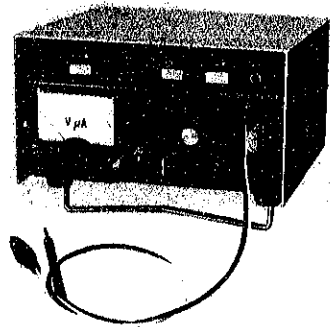

### 5. Battery holding spring S-812

Used for securing battery and flowing current when the movement is removed from the case.

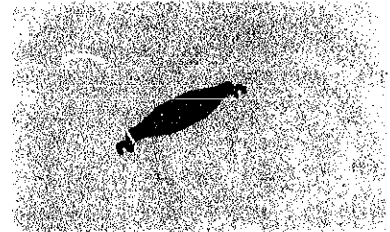

### 3. Volt-ohm-meter

Used to check circuit block and its conductivity, to measure current consumption, and to check battery voltage.

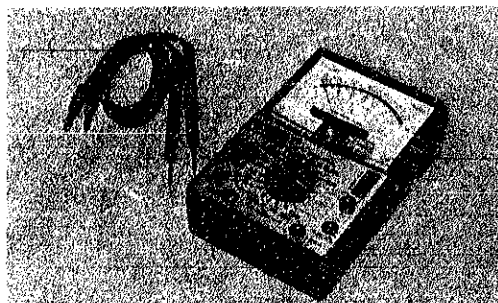

### 6. Static electricity protector S-830

Used to protect the C-MOS-LSI of the circuit block of Digital Quartz from being damaged by static electricity.

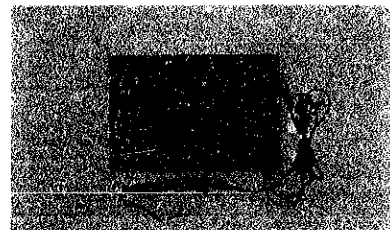

## MORE DETAILED EXPLANATION FOR STATIC ELECTRICITY

### The reason of necessity:

When repairing the movement of the SEIKO Digital Quartz, be sure to use the Static Electricity Protector, S-830, in order to protect its circuit block from being damaged by static electricity.

The human body and clothes are often charged with static electricity of from several thousands to several tens of thousands of volts, depending on environmental conditions. If this high voltage static electricity flows directly through the circuit block, the C-MOS-LSI will be damaged. The Static Electricity Protector, S-830, shunts the static electricity to ground, protecting the circuit block when it is repaired.

### How to use

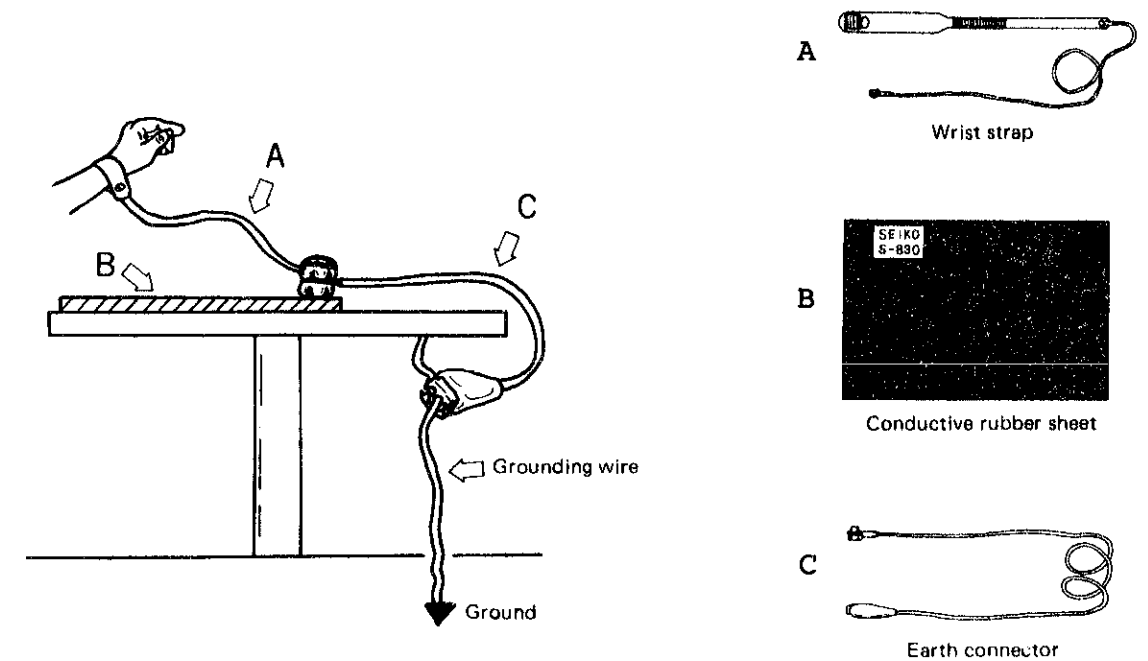

- Set up the Static Electricity Protector as illustrated above, and place the movement of the Digital Quartz Watch on the conductive rubber sheet (B) for repair. This rubber sheet is specially processed to have a conductivity for discharging static electricity.
- Put the wrist strap (A) direct around the naked skin, and not over clothing.
- Be sure to connect the earth connector (C) to the grounding wire directly connected to the ground, or connect the earth connector (C) to the grounding wire which is connected to the earth terminal at the outlet or a metallic water service pipe for the same effect.

### III. DISASSEMBLING AND REASSEMBLING OF THE CASE

#### How to remove the digit adjusting stem with crown

Depending on the case model to be disassembled, choose and follow one of the two disassembling procedures which are illustrated below.

##### • Disassemble from the panel side.

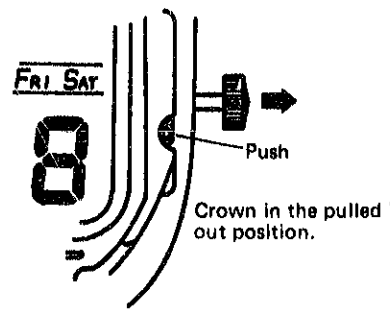

##### • Disassemble from the battery side.

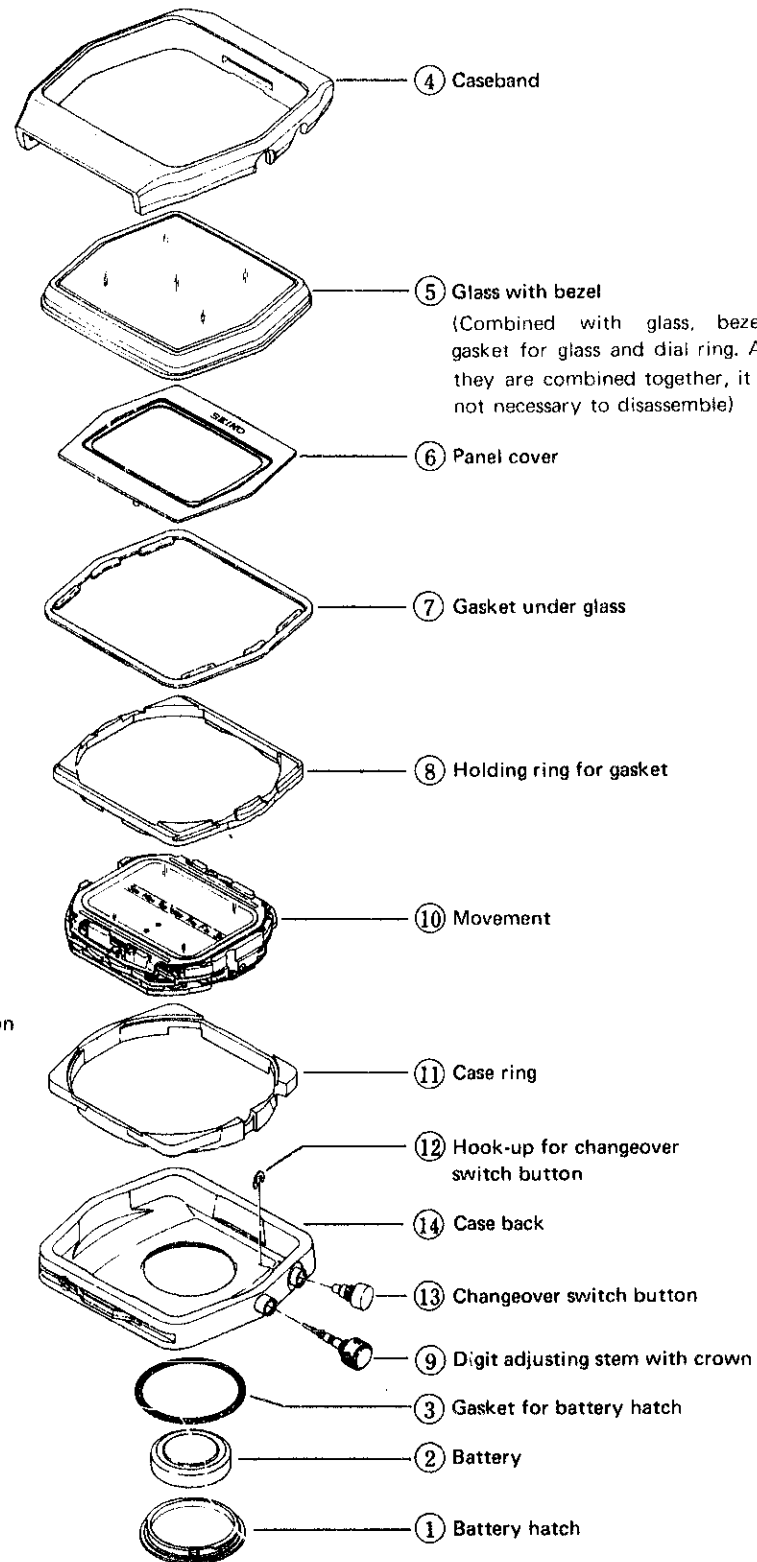
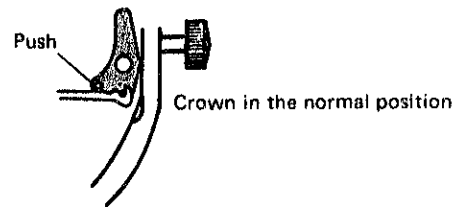

#### Case No. 0139-5029

The panel cover is supported by both the caseband and the glass. As the inside diameter of the panel cover is smaller than the outside diameter of the glass, follow the procedures below when the glass is removed and fixed.

##### • How to remove the glass

Remove the glass by using the inserting disk as shown in the illustration below. Do not push the panel cover with the inserting disk or the panel cover will be damaged.

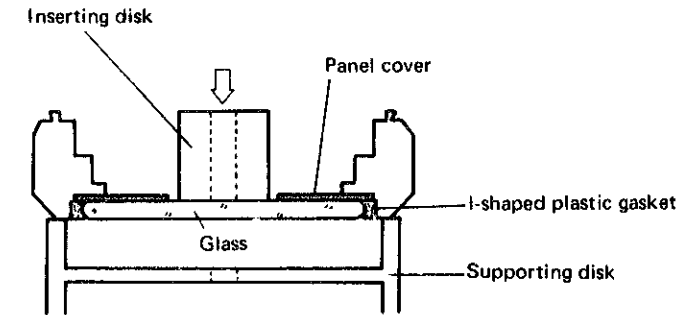

Inserting disk to be used: S-160

Inserting disk:  $\phi$  14.5 mm (diameter)  
Supporting disk:  $\phi$  35.0 mm (diameter)

##### • How to fix the glass

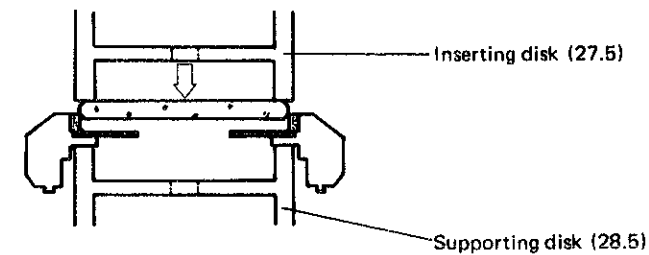

Inserting disk to be used: S-160

Inserting disk:  $\phi$  27.5 mm (diameter)  
Supporting disk:  $\phi$  28.5 mm (diameter)



- There is no difference in front and back of the glass.
- After ascertaining the glass is placed on the I-shaped plastic gasket in parallel with the caseband, push the glass in the caseband.
- Do not apply silicon grease around the I-shaped plastic gasket.
- After ascertaining the upper and lower side of the gasket, push it in the caseband. Do not use the I-shaped plastic gasket again, which has been already used.



## IV. DISASSEMBLING, REASSEMBLING, LUBRICATING AND CLEANING

- Disassembling and reassembling

Disassembling procedures Figs.: ① ~ ③①

Reassembling procedures Figs.: ③① ~ ①

- Lubricating:  SEIKO Watch Oil S-6

- Quantity of oils:  Normal quantity

### 1. Liquid crystal panel side

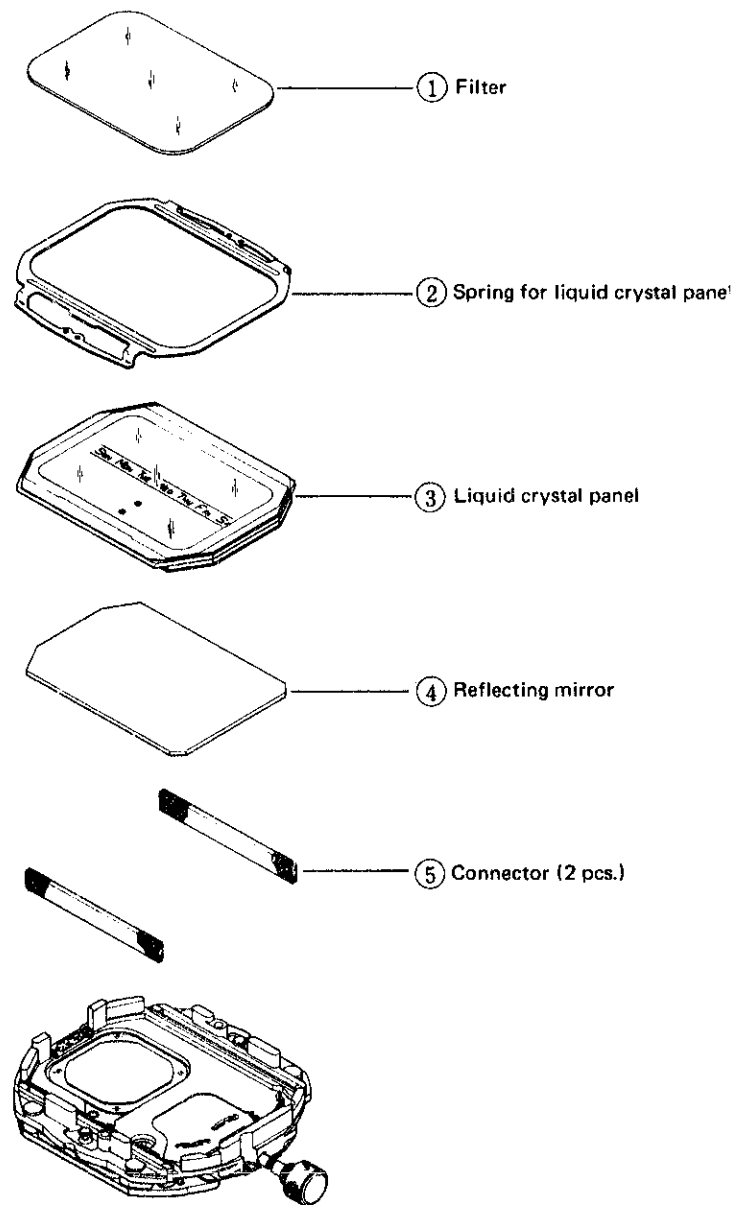

### Remarks for disassembling and reassembling

#### ② Spring for liquid crystal panel

Insert the tips of the tweezers into the two holes of the spring for liquid crystal panel and pry it up in the arrow-marked direction for disassembling.

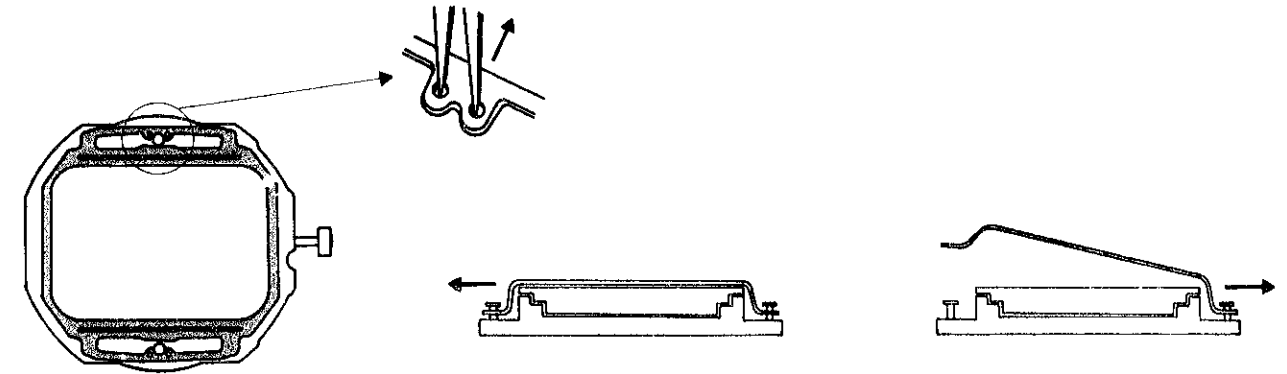

#### ③ Liquid crystal panel

Use fingercots to disassemble and reassemble the liquid crystal panel. Be careful not to touch the surface of the liquid crystal panel with your fingertips.

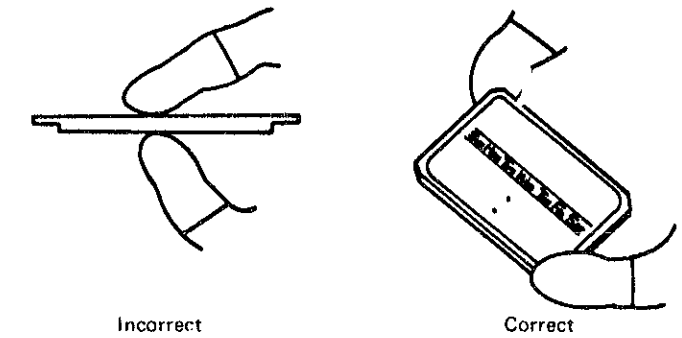

#### ④ Reflecting mirror

Check to see if there are any scratches, contamination, lint or dust on the surface.

#### ⑤ Connector

Although two connectors are used, there is no difference between the two. The black portions are conductive. Check to see if there are any scratches or contamination.

## 2. Switch mechanism side

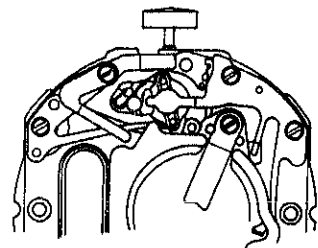
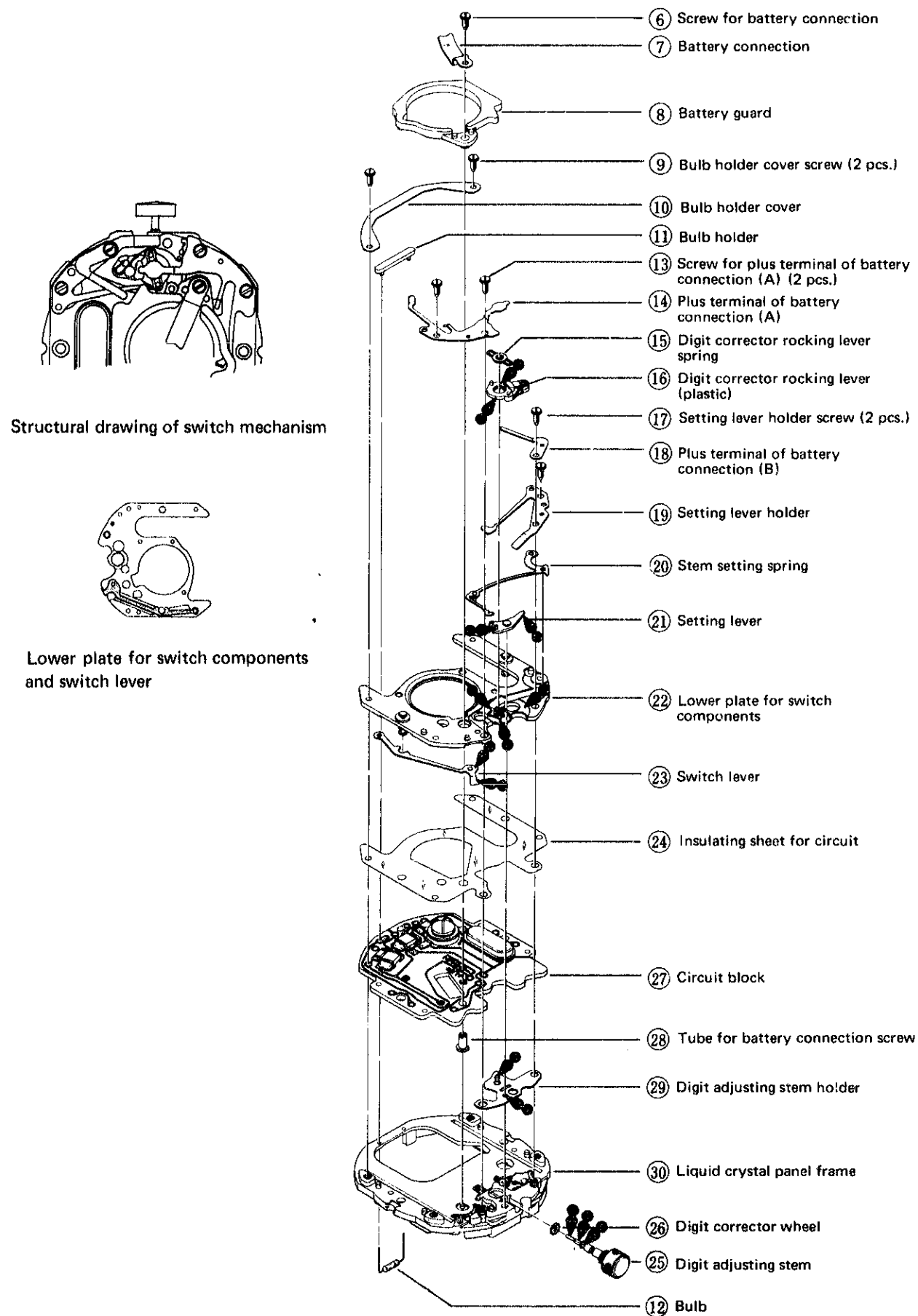

Structural drawing of switch mechanism

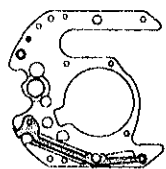

Lower plate for switch components and switch lever

## Remarks for disassembling and reassembling

### 12 Bulb

When replacing the bulb, disassemble the bulb holder.

The bulb can be replaced even if the switch mechanism is not disassembled. Be sure that the bulb is fixed in position without leaving any space between the bulb and the liquid crystal panel frame. And be careful not to touch the lead wires of the bulb to any other circuit patterns.

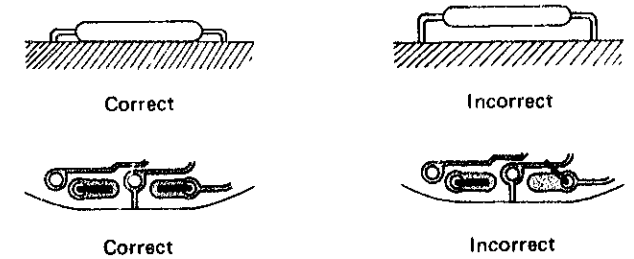

### 16 Digit corrector rocking lever

1) Lubricate the switch cam

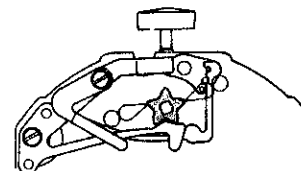

Lubricate more than two teeth of the switch cam. The teeth should be lubricated on the side portion of the teeth near the tip.

2) Set the digit corrector rocking lever

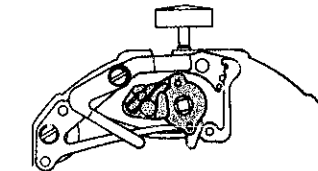

Insert the switch pin of digit corrector rocking lever into the hole of lower plate for switch components.

3) Set the digit corrector rocking lever spring

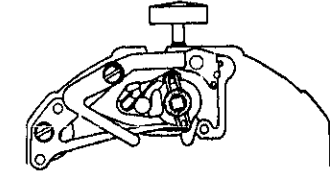

Place the digit corrector rocking lever spring on the digit corrector rocking lever and while slightly pushing the lever, with fingertips turn the crown. Then the digit corrector rocking lever spring will be set in the correct position.

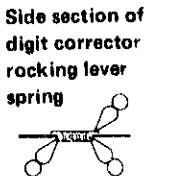

The contact point lever spring is incorporated into the digit corrector rocking lever. Do not disassemble the contact point lever spring except in case of replacement. When reassembling the contact point lever spring, place it as shown in the illustration.

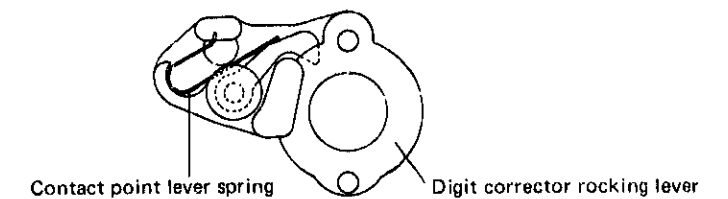

### 20 Stem setting spring

How to reassemble

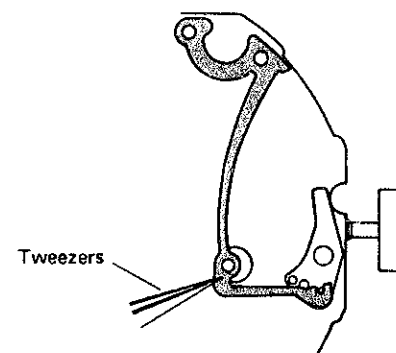

Pry up with tweezers for disassembling

How to disassemble

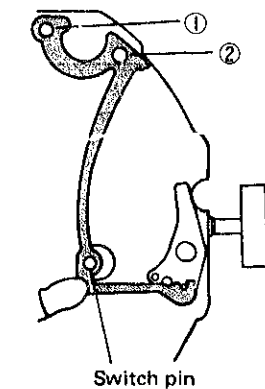

Set the switch pin of the stem setting spring on the lower plate for switch components. While holding the switch pin with a finger, set the two portions ① and ② on the two pins. After setting the setting lever holder, engage the tip of the stem setting spring to the pin of the setting lever.

27) **Circuit block**

Circuit block has a number of patterns. When disassembling and reassembling, be sure to pick up the circuit block with tweezers or finger tips with fingercots by the portion marked with mesh.

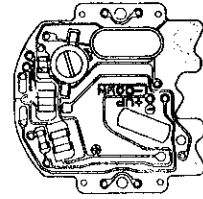

28) **Tube for battery connection screw**

Be sure to set the tube for battery connection screw in the liquid crystal panel guard.

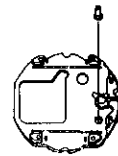

30) **Liquid crystal panel frame**

Do not take out the switch springs (5 pcs.) except in case of replacement. If the switch springs are taken out, set them in the same positions and directions as shown in the illustration.

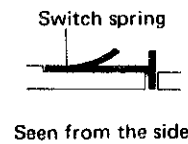

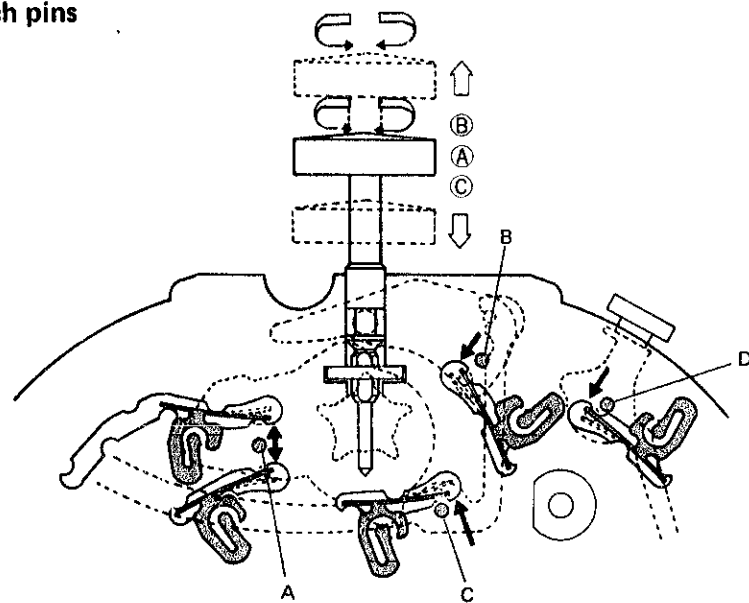

3. **Relation between the switch springs and the switch pins**

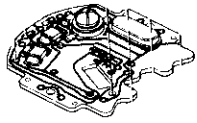
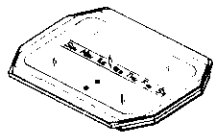
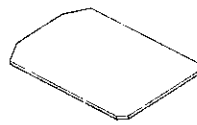

- 1) Changeover from date display to second display and vice versa  
 ... Turn the crown in the normal position → Digit corrector rocking lever (Switch pin A) touches the switch spring.
- 2) Adjustment of display
  - Pull out the crown → Setting lever (switch pin B) touches the switch spring → Digits are ready to be adjusted
  - Turn the crown in the first click → Digits corrector rocking lever (switch pin A) touches the switch spring—
    - Selection of the digits adjusted by turning the crown clockwise.
    - Adjustment of the digits by turning the crown counterclockwise.
- 3) Activating the light  
 ... Push the crown → Stem setting spring (Switch pin C) touches the switch spring.
- 4) Changeover of display  
 ... Push the side button → Switch lever (Switch pin D) touches the switch spring.

4. **Cleaning**

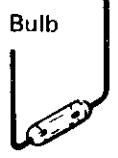
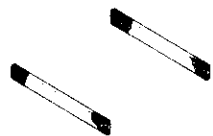
Name of parts	Cleaning	Drying	Solution	Remarks
Circuit block 	DO NOT CLEAN			<ul style="list-style-type: none"> <li>● Clean the conductive portion only with a cloth moistened with benzine. Dry in <u>COOL</u> air.</li> <li>● Wipe dust and lint off with a soft, dry brush.</li> </ul>
Liquid crystal panel 				
Reflecting mirror 				
Filter 				
Bulb 				
Connector 	Rinse or scrub with a soft brush	Cool air	Alcohol	
Plastic parts	Rinse or scrub with a soft brush	Cool air	Benzine, alcohol	
Other parts	Clean with cleaner, rinse or scrub with a soft brush	Hot or cool air	Benzine, trichloroethylene or alcohol	

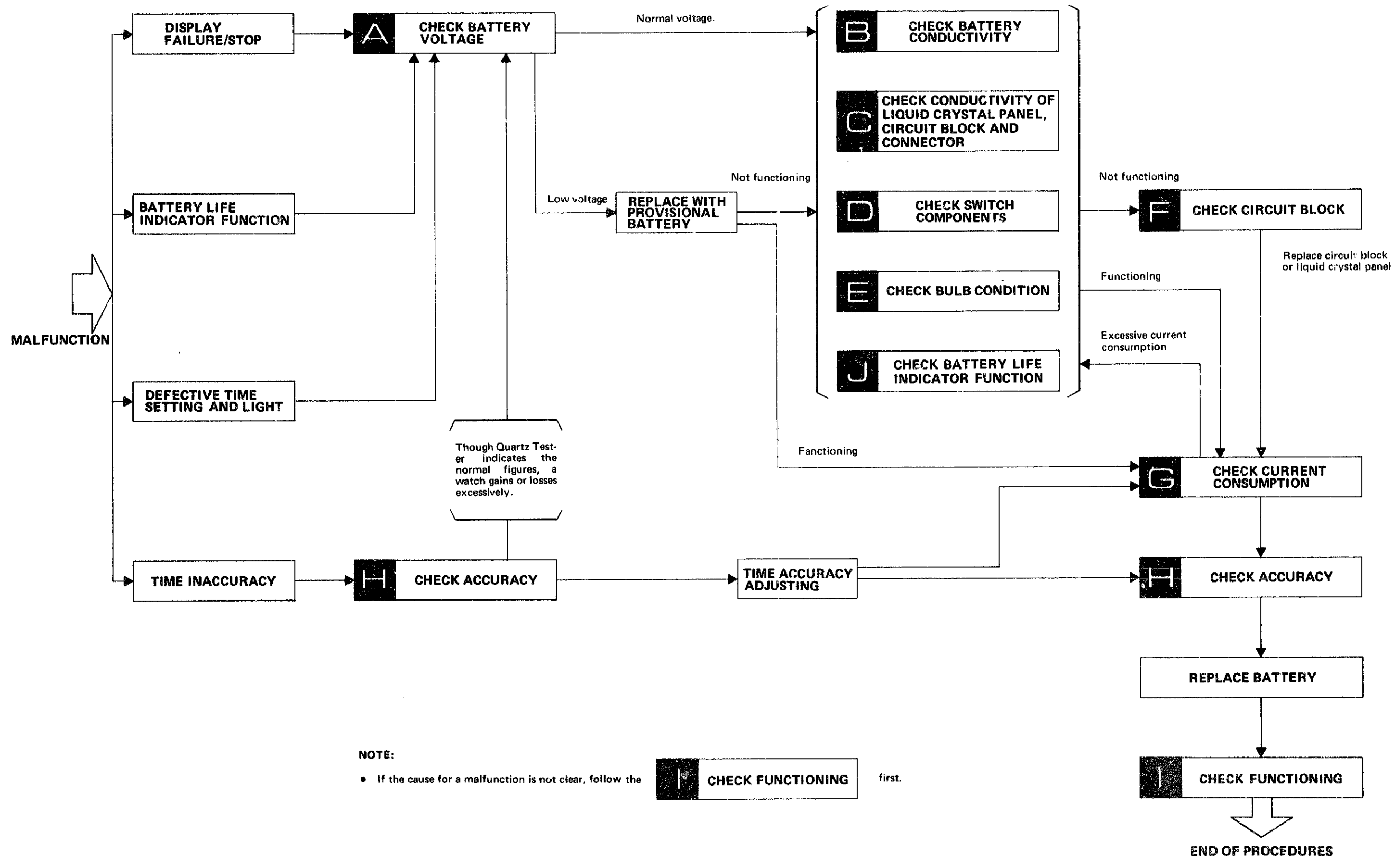

# V. CHECKING AND ADJUSTMENT

## 1. Guide table for checking and adjustment

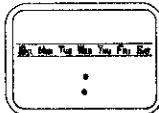
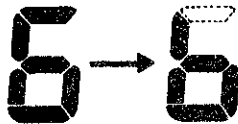

## 2. Malfunction and checking points

- Check in numerical order
- Refer to "Procedures for checking and adjustment" on page 17.

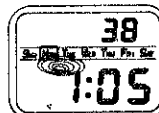
FAULTY SYMPTOMS		CHECKING PORTIONS								
		A	B	C		D	E	F	J	
		Battery	Battery conductivity	Liquid crystal panel	Circuit block	Connector	Setting mechanism	Bulb	Circuit block	Battery life indicator function
DISPLAY FAILURE	Stop (Though the digits are displayed, digits figures do not change.)	①	②		④		③			
	No digital display, dim display or extremely poor response. 	①	②	④	⑤	⑥	③		⑦	
	Some segments of the digital figures are not lighted or dim. 			②	③	①				
	All segments are displayed or the segment which should be on and off are reversed as shown in the illustration. 			②	③	①				
	Some portions of the liquid crystal panel will make black dots or iridescent circles. 			①						
TIME INACCURACY	Gain or loss tested by the Quartz Tester.	①	②							
	Though Quartz Tester indicates the normal figures, a watch gains or loses when it is worn on the wrist.	①	②		③					
DEFECTIVE TIME SETTING OR LIGHT	Light is not lit or light is lit but dims soon.	①					③	②		
	Digits adjusting is impossible or the digital display is extinguished while digits adjusting is being made.				②				①	
	All digits displayed are flashing.	①								②

### 3. Procedures for checking and adjustment

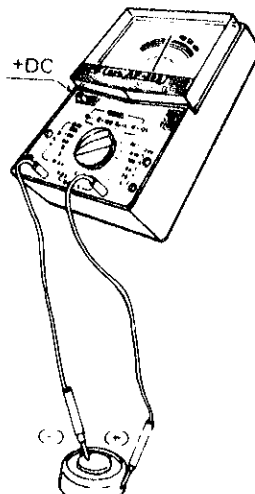
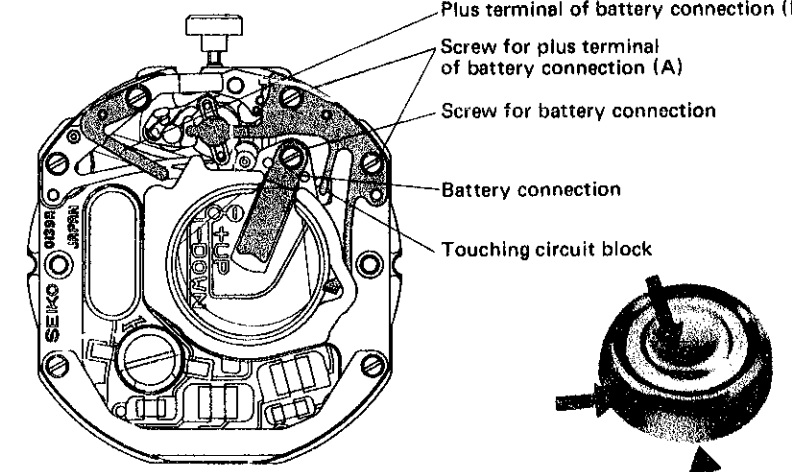
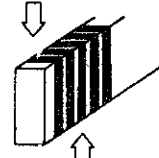
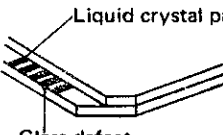
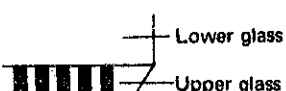
	Procedure	Result
CHECK BATTERY VOLTAGE	<p>Use the following procedures to check battery voltage.</p> <p>(1) <b>Set up the volt-ohm-meter</b> Range to be used: DC 3 V</p> <p>(2) <b>Measuring</b></p> <ul style="list-style-type: none"> <li>● Probe Red (+) . . . Battery surface (+)</li> <li>● Probe Black (-) . . . Battery surface (-)</li> </ul> 	<p>More than 1.5 V ..... Normal Less than 1.5 V ... Defective → Replace battery</p>
CHECK BATTERY CONDUCTIVITY	<p>(1) Check for any contamination on the battery, battery connection and plus terminal of battery connection, (A), (B).</p> <p>(2) Make sure that the screw for battery connection and the screw for plus terminal of battery connection (A) are tightened firmly.</p> 	<p>Uncontaminated .... Normal Contaminated :.... Defective → Wipe off any foreign matter.</p> <p>No loosened screws . Normal Loosened screws ... Defective → Retighten screw.</p>
CHECK CONDUCTIVITY OF LIQUID CRYSTAL PANEL, CIRCUIT BLOCK AND CONNECTOR	<p>(1) Check for stain, crack and tiny break in the connector.</p>  <ul style="list-style-type: none"> <li>● Check carefully the connecting portions of the liquid crystal panel and the circuit block.</li> </ul> <p>(2) Check the liquid crystal panel electrode (connecting portion of the connector) for any foreign matter and glass defect.</p>  <p>Liquid crystal panel electrode Glass defect</p>  <p>Lower glass Upper glass</p> <p>More than one third of the glass is defective Replace liquid crystal panel</p>	<p>No foreign matter ... Normal Contaminated ..... Defective → Wipe off with a cloth moistened with alcohol.</p> <p>Crack or tiny break . . . . Defective → Replace the connector with new one.</p> <p>Uncontaminated .... Normal Contaminated ..... Defective → Wipe off with a cloth moistened with alcohol.</p> <p>Glass defects ..... Defective → Replace liquid crystal panel with a new one.</p>

**Procedure**

**Result**

(3) If segments are dead (Some segments are partially dimmed), check liquid crystal panel.

**1. Set up the volt-ohm-meter**

- In case AF 105 volt-ohm-meter is used.  
Range to be used: OHMS R × 1
- In case other volt-ohm-meter is used.  
Range to be used: R × 1  
If no display appears when the above range "R × 1" is used, change the range to other ones such as "R × 10K"

2. Check for any dead segments on the liquid crystal panel and if any, remove the liquid crystal panel from the movement and turn the panel upside down.

3. Apply red and black probes of the volt-ohm-meter to the common electrode of the liquid crystal panel and the electrode of defective segments.  
(Either red or black probe can be applied to both electrodes.)

Common electrode

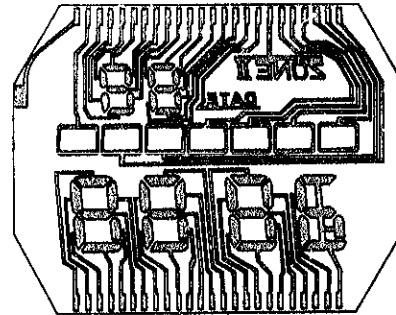

Check the position of the common electrode as shown in the illustration.

Note: The panel pattern might be seen if the pattern is looked through askance.

(4) Check for any contamination on the circuit block electrode and the tube for battery connection screw.

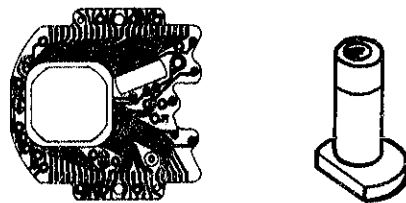

Function of the tube for battery connection screw. To flow electric current from the battery (-) to the circuit (+).

Lights up ..... Normal  
Does not light up .. Defective  
→ Replace liquid crystal panel.

Uncontaminated ..... Normal  
Contaminated ..... Defective  
→ Wipe off with a cloth moistened with alcohol.

(1) Check for any contamination and defects on the switch spring (5 pcs.) and switch pins A, B, C and D.

Digit corrector rocking lever (switch pin A)

Setting lever (switch pin B)

Switch lever (switch pin D)

Stem setting spring (switch pin C)

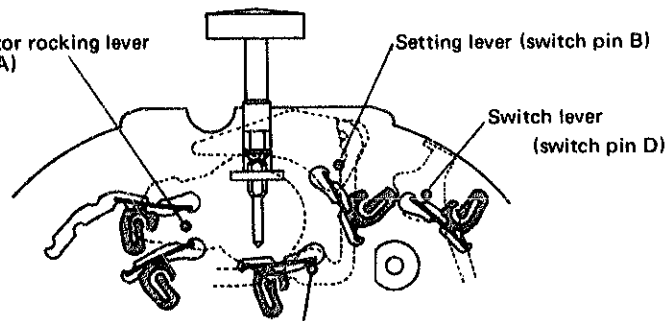

Uncontaminated and no defects ..... Normal  
Contaminated ..... Defective  
→ Wipe off carefully.

Defects ..... Defective  
→ Replace the defective parts (with switch pin) or switch spring.

**Procedure**

**Result**

(2) In case changeover from date display to second display or vice versa is impossible. Check to see if the digit corrector rocking lever (switch pin A) is correctly set.

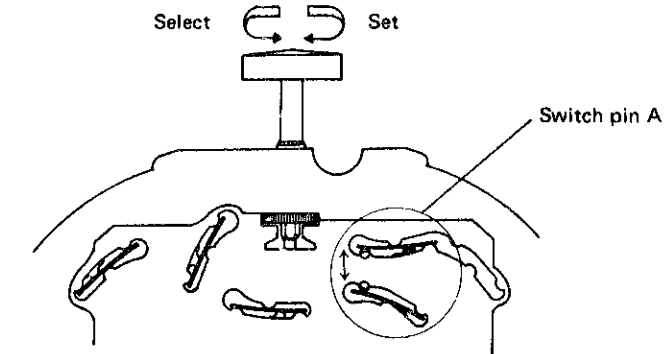

If the crown is turned clockwise and counterclockwise in the normal position or in the first click position, the switch cam turns clockwise and counterclockwise and the digit corrector rocking lever (switch pin A) touches the switch spring, which if the crown is in the normal position, makes it possible for the date and second display to be changed from one to the other and which if the crown is pulled out to the first click, enables the display to be adjusted.

(3) In case adjustment of display is impossible. Check to see if the setting lever (switch pin B) is correctly set.

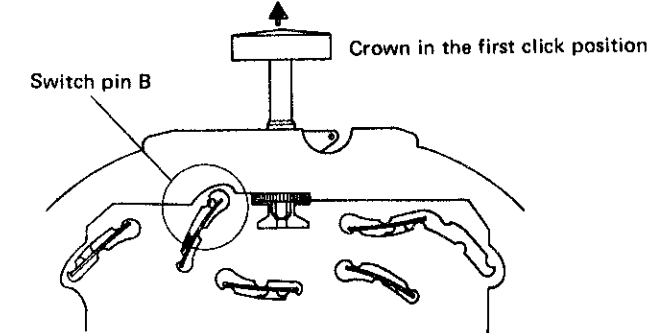

Switch pin B touches the switch spring, which makes it possible for the display to be adjusted.

(4) In case the bulb does not light up. Check to see if the stem setting spring (switch pin C) is correctly set.

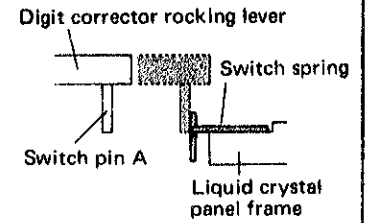
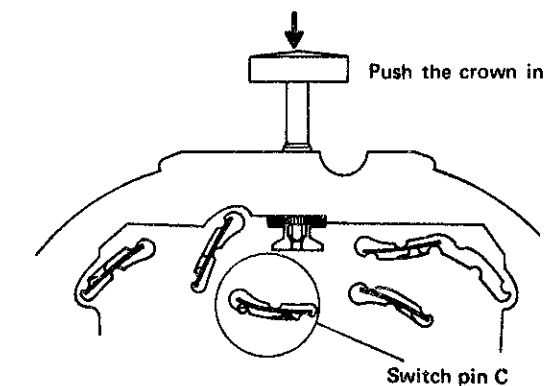

Touches the switch spring ... Normal  
Does not touch the switch spring ..... Defective → Replace the switch spring with a new one.  
Switch pin A is bent ..... Defective → Replace the digit corrector rocking lever with new one.

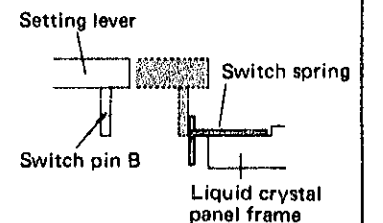

Touches the switch spring ... Normal  
Does not touch the switch spring ..... Defective → Replace the switch spring with a new one.  
The switch pin B is bent ..... Defective → Replace the setting lever with a new one.

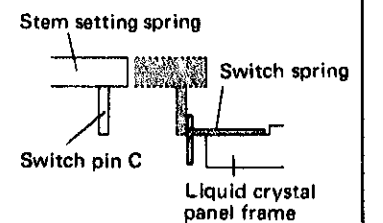

Touches the switch spring ... Normal  
Does not touch the switch spring → The switch spring is bent ..... Defective → Replace the switch spring with a new one.  
The switch pin C is bent ..... Defective → Replace the stem setting spring with a new one.

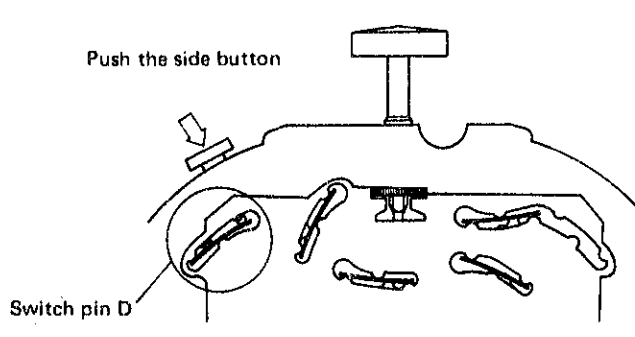
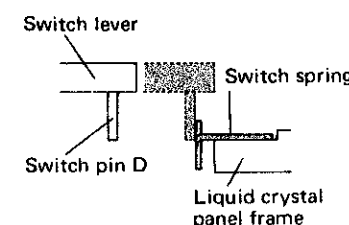
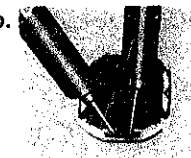
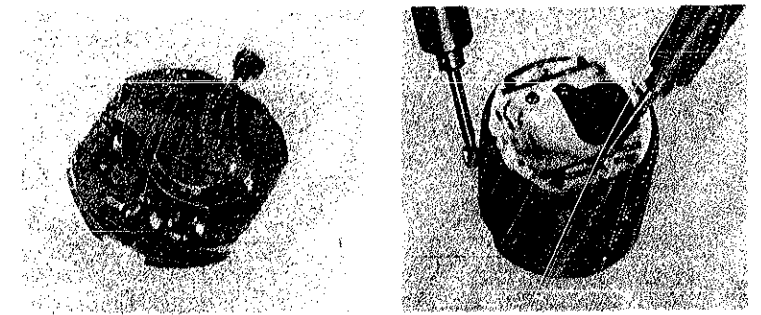
	Procedure	Result
CHECK SWITCH COMPONENTS	<p>(5) In case changeover from the Basic Display to the Zone II Display or vice versa is impossible. Check to see if the switch lever (switch pin D) is correctly set.</p>  <p>Push the side button</p> <p>Switch pin D</p> <p>The switch lever (Switch pin D) touches the switch spring and changeover from Basic Display (12-hour indicator) to Zone II Display (24-hour indication) and vice versa become possible.</p>	 <p>Switch lever</p> <p>Switch pin D</p> <p>Switch spring</p> <p>Liquid crystal panel frame</p> <p>Touches the switch spring ... Normal Does not touch the switch spring → The switch spring is bent .... Defective → Replace the switch spring with a new one. The switch pin D is bent .... Defective → Replace the switch lever with a new one.</p>
CHECK BULB CONDITION	<p>Check to see if there is a broken filament in the bulb.</p> <p>1. <b>Set up the volt-ohm-meter</b> Range to be used: OHMS R × 1</p> <p>2. <b>Checking</b> Apply the probes (Either red or black probe will do) to the two terminals of the bulb.</p>  <p>Remove the bulb holder and the bulb holder cover.</p>	<p>Light is lit ..... Normal Light is not lit .... Defective → Replace the bulb with a new one.</p>
CHECK CIRCUIT BLOCK	<p>Check to see if an electric signal flows normally from the circuit block to the liquid crystal panel.</p> <p>1. According the disassembling procedures, remove the spring for liquid crystal panel, filter and liquid crystal panel.</p> <p>2. Put the battery into the movement and secure it with the battery holding spring.</p> <p>3. <b>Set up the Volt-ohm-meter</b> Range to be used: DC3V</p> <p>4. <b>Measuring</b></p> <ul style="list-style-type: none"> <li>● Probe Red (+) . . . . Crown or digit adjusting stem</li> <li>● Probe Black (-) . . . . Black portion of connector</li> </ul> 	<p>0.8 V ~ 1.4 V .... Normal Out of the above range .... Defective → Replace the circuit block with a new one. (The above voltage figures are obtained only if AF-105 type Volt-ohm-meter shown on the Technical Guide or a type of Volt-ohm-meter with higher internal resistance is used.)</p>
	<p><b>NOTE:</b> Touch the connector lightly with the probes.</p>	

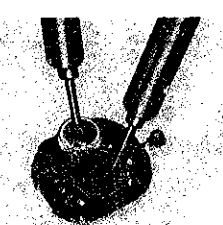
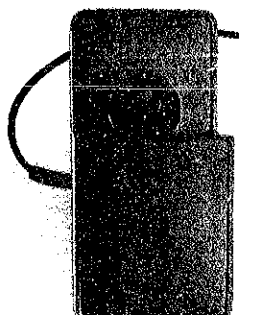
	Procedure	Result
CHECK CURRENT CONSUMPTION	<p>Check to see if the current consumption is normal</p> <p>1. <b>Set up the Volt-ohm-meter</b> Range to be used: DC 0.03 mA</p> <p>2. <b>Measuring</b> Probe Red (+) . . . . . Battery connection Probe Black (-) . . . . . Battery surface (-)</p>  <p>Place the battery on the metal housing of the crystal oscillator with its minus surface turned up.</p>	<p>Less than 4.2 <math>\mu</math>A → Normal More than 4.2 <math>\mu</math>A → Defective → Proceed to <b>B C D E</b></p>
CHECK ACCURACY	<p>Check gain and loss of time.</p> <ul style="list-style-type: none"> <li>● <b>Set up the Quartz Tester</b> Use the electric-field detection microphone for the liquid crystal watch.</li> </ul> 	
TIME ACCURACY ADJUSTING	<p>Time accuracy is adjusted by turning the trimmer condenser. The watch will gain or lose according to the direction in which the trimmer condenser is turned. Adjustment should therefore be made after ascertaining with the Quartz Tester whether the watch tends to gain or lose.</p> <ul style="list-style-type: none"> <li>● Note for handling the trimmer condenser Avoid excessive depressing and turning of the trimmer condenser.</li> </ul>	



<b>CHECK FUNCTIONING</b>	<b>I</b>	<p>Check to see if each time setting function works correctly using the crown operation.</p> <p><b>Note:</b>          Incomplete digital figures may show on the display panel after battery replacement. However, this is not a malfunction. Should this occur, pull out the crown to the first click and push it back to normal position.          Now, the electronic circuit is in a reset condition.          Pull out the crown again and adjust the time in accordance with the time signal.</p> <p><b>1. First check</b>          Turn the crown clockwise and counterclockwise in the normal position and check to see if the date display is changed to the second display and vice versa.</p> <p><b>2. Second check</b>          Push the side button in to check if the display changes from the Basic Display to the Zone II Display and vice versa.</p> <p><b>3. Third check</b>          Pull out the crown to the first click and turn clockwise and counterclockwise to see if selection and setting of the date, the day of the week, the hour and the minute can be made correctly. Next, change the mode and check in the same way. Make sure that there is no dead segment.</p> <p><b>4. Fourth check</b>          Pull out the crown to the first click and push it back to see if the second display is reset to "00" (When the seconds count any numbers from "00" to "29", the seconds are reset to "00" automatically. When, however, the seconds count any numbers from "30" to "59", one minute is added and the seconds immediately return to "00".)</p> <p><b>5. Fifth check</b>          Depress the crown at the normal position and make sure that the light is lit.</p>

	Procedure	Result
<b>CHECK BATTERY LIFE INDICATOR FUNCTION</b>	<p style="text-align: center;"><b>U</b></p> <p><b>1. First check</b></p> <p>(1) Set up the Micro Test.            Voltage to be used: 1.1 V</p> <p>(2) Touch the watch slightly with the probe and clip.            Clip Red (+) . . . . . Crown or stem            Probe Black (-) . . . Battery connection</p> <p>(3) Set the time at 11:59 A.M. of the Basic Display (12-hour Indication).</p> <p>(4) Check to see if the battery life indicator functions correctly (all digital display start flashing) when the display indicates 12:00.</p>	<p>Flashing ..... Normal</p> <p>No flashing ..... Replace the circuit block with a new one.</p>
	<p><b>2. Second check</b></p> <p>(1) Set up the Micro Test.            Voltage to be used: 1.5 V</p> <p>(2) Follow the same procedures as in (2) ~ (4) of the First check.</p>	<p>No flashing ..... Normal            Flashing ..... Replace the circuit block with a new one.</p>
<p>All procedures of Disassembling, Reassembling, Checking and Adjustment are completed.</p>		