

SEIKO

QUARTZ LC

Cal.0532A

PARTS LIST

Calibre No. <h1 style="text-align: center;">0532A</h1>	Jewels <h1 style="text-align: center;">0j</h1>	Style Name <h1 style="text-align: center;">QUARTZ <i>LC</i></h1>
--	--	--

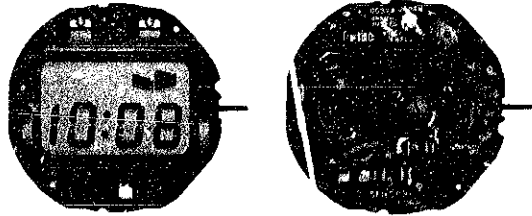

Characteristics

Casing diameter : ϕ 27.80 mm
 Maximum height : 6.86 mm
 Frequency of quartz crystal oscillator : 32,768 Hz
 (Hz = Hertz Cycle per second)
 Time functions : Digital Display System showing hour, minute & 10-second unit indicator
 Calendar functions : Digital Display System showing month & date (2-second display by turning the crown at the normal position)
 Time micro-adjustor : Trimmer condenser system
 Illumination light for digital display panel : Illuminated in coordination with the crown depressing

354 048

383 032

389 003

4001 073

4242 052

4245 012

4245 013

4245 014

4270 053

4295 003

4299 010

4313 017

4446 008

4450 003

4510 103

4511 002

4521 005

4521 006

4530 006

4540 001



U.C.C. 392



012 453



013 381



017 087













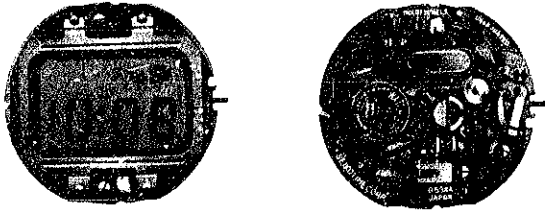



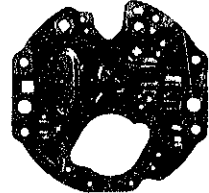





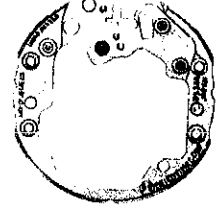

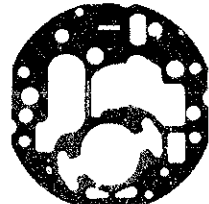
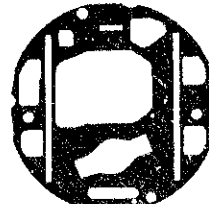

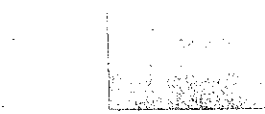

017 088

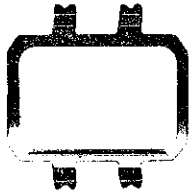

017 504 $\frac{2}{1}$

Calibre No. 0532A		Jewels 0j	Style Name QUARTZ LC	
PART NO.	PART NAME	PART NO.	PART NAME	
354 048	Digit adjusting stem			
383 032	Setting lever			
389 003	Setting lever axle spring			
4001 073	Circuit block			
4242 052	Plus terminal of battery connection			
4245 012	Switch spring (A)			
4245 013	Switch spring (B)			
4245 014	Switch spring (C)			
4270 053	Battery connection			
4295 003	Switch cam			
4299 010	Lower plate for switch components			
4313 017	Connector			
4446 008	Spacer for liquid crystal panel			
4450 003	Switch lever			
4510 103	Liquid crystal panel			
4511 002	Filter			
4521 005	Reflecting mirror (Silver)			
4521 006	Reflecting mirror (Brown)			
4530 006	Bulb (with terminal)			
4540 001	Spring for liquid crystal panel			
012 453	Lower plate screw for switch components			
012 453	Setting lever axle spring screw			
012 453	Screw for plus terminal of battery connection			
013 381	Bulb pin			
017 087	Lower plate stop tube for switch components			
017 088	Setting lever axle spring stop tube			
017 504	Screw support for plus terminal of battery connection			
U.C.C.392	Silver oxide battery			

SEIKO

<p>Calibre No.</p> <h2 style="text-align: center;">Q534A</h2>	<p>Style Name</p>
	<p>Characteristics</p> <p>Casing diameter : ϕ 28.0 mm Maximum height : 6.85 mm Frequency of quartz crystal oscillator: 32,768 Hz (Hz=Hertz Cycle per second) Time functions : Digital Display System showing hour, minute & 10-second unit indicator Calendar functions : Digital Display System showing month & date (2-second display by turning the crown at the normal position) Time micro-adjustor : Trimmer condenser system Illumination light for digital display panel : Illuminated in coordination with the crown depressing Battery life indicator : The entire display beeping flashing</p>
<div style="display: flex; flex-wrap: wrap; justify-content: space-around;"> <div style="text-align: center; margin: 5px;"> 354 048</div> <div style="text-align: center; margin: 5px;"> 383 032</div> <div style="text-align: center; margin: 5px;"> 389 005</div> <div style="text-align: center; margin: 5px;"> 4001 067</div> <div style="text-align: center; margin: 5px;"> 4242 062</div> <div style="text-align: center; margin: 5px;"> 4245 013</div> <div style="text-align: center; margin: 5px;"> ☆4245 014</div> <div style="text-align: center; margin: 5px;"> 4245 016</div> <div style="text-align: center; margin: 5px;"> 4270 018</div> <div style="text-align: center; margin: 5px;"> 4295 003</div> <div style="text-align: center; margin: 5px;"> 4299 014</div> <div style="text-align: center; margin: 5px;"> 4313 016</div> <div style="text-align: center; margin: 5px;"> 4398 022</div> <div style="text-align: center; margin: 5px;"> 4398 023</div> <div style="text-align: center; margin: 5px;"> 4450 003</div> <div style="text-align: center; margin: 5px;"> ☆4510 111</div> <div style="text-align: center; margin: 5px;"> ☆4510 112</div> <div style="text-align: center; margin: 5px;"> 4511 002</div> <div style="text-align: center; margin: 5px;"> ☆4521 005</div> <div style="text-align: center; margin: 5px;"> ☆4521 006</div> <div style="text-align: center; margin: 5px;"> 4530 006</div> <div style="text-align: center; margin: 5px;"> 4540 001</div> <div style="text-align: center; margin: 5px;"> U.C.C.392</div> <div style="border: 1px solid black; padding: 5px; margin: 5px; display: flex; justify-content: space-around;"> <div style="text-align: center;"> 012 453</div> <div style="text-align: center;"> 012 454</div> <div style="text-align: center;"> 013 383</div> <div style="text-align: center;"> 017 504 $\frac{2}{1}$</div> </div> </div>	

Calibre No.		Style Name	
0534A			
PART NO.	PART NAME	PART NO.	PART NAME
354 048	Digit adjusting stem		
383 032	Setting lever		
389 005	Setting lever axle spring		
4001 067	Circuit block		
4242 062	Plus terminal of battery connection		
4245 016	Switch spring (A)		
4245 013	Switch spring (B)		
4245 014	Switch spring (C)		
4270 018	Battery connection		
4295 003	Switch cam		
4299 014	Lower plate for switch components		
4313 016	Connector		
4398 023	Battery guard		
4398 023	Liquid crystal panel frame		
4450 003	Switch lever		
☆4510 111	Liquid crystal panel		
☆4510 112	Liquid crystal panel		
4511 002	Filter		
4521 005	Reflecting mirror (Silver)		
4521 006	Reflecting mirror (Brown)		
4530 006	Bulb (with terminal)		
4540 001	Spring for liquid crystal panel		
012 453	Lower plate screw for switch components		
012 453	Setting lever axle spring screw		
012 453	Screw for plus terminal of battery connection		
012 454	Liquid crystal panel frame screw		
013 383	Bulb pin		
017 504	Screw support for plus terminal of battery connection		
U.C.C.392	Silver oxide battery		
Remarks :			
Liquid crystal panel			
☆4510 111.....Green display of 10-second unit indicator			
☆4510 112.....Black display of 10-second unit indicator			
The type of a liquid crystal panel is determined based on the design of cases and panel covers. Check the case number and refer to the SEIKO Digital Quartz Casing Parts List for Japan to choose the corresponding liquid crystal panel.			

☆⇨ Please see remarks.

Part numbers in light letters are not shown in photos.

TECHNICAL GUIDE

SEIKO

DIGITAL QUARTZ

CAL.0532A

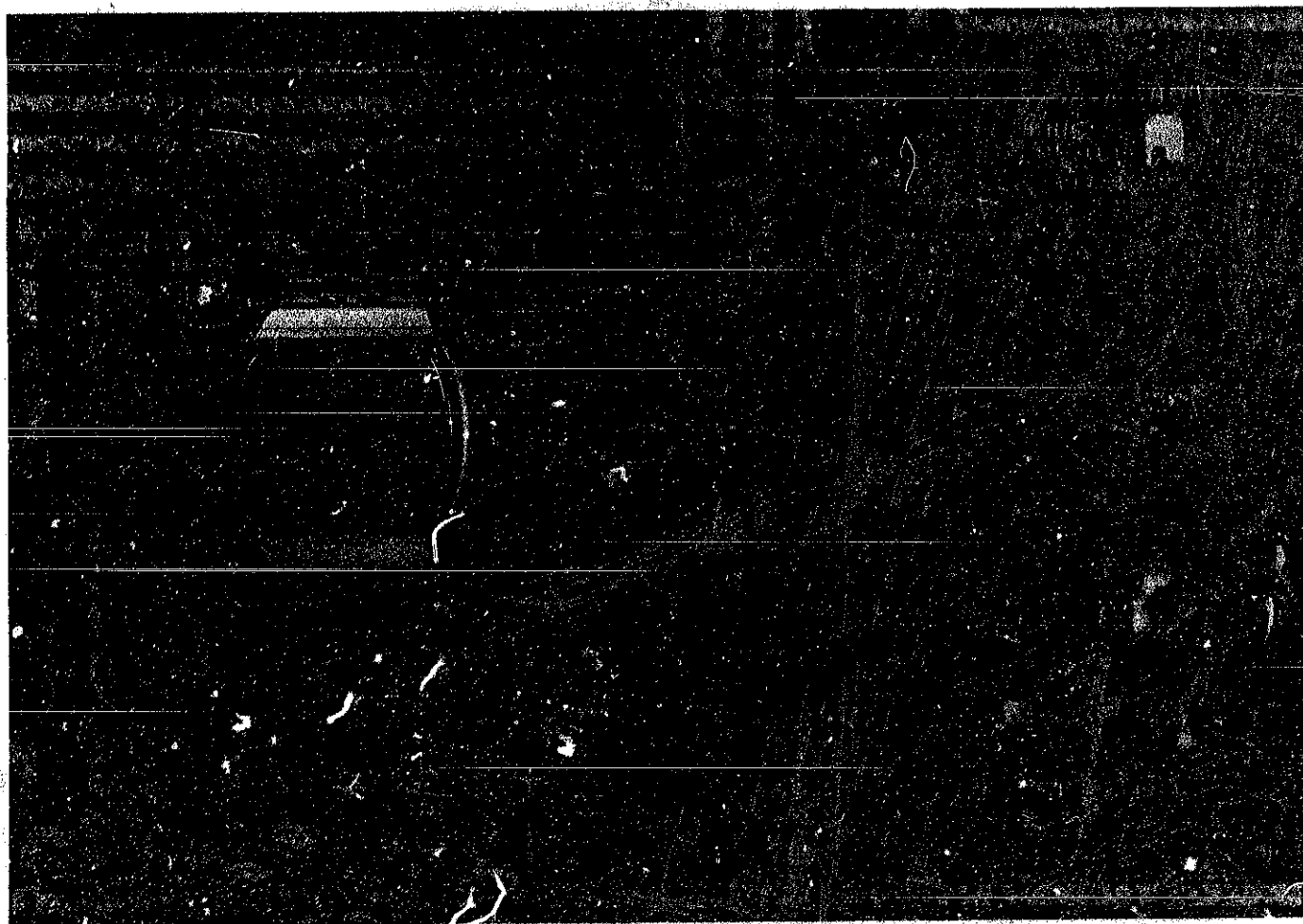

CONTENTS

I. SPECIFICATIONS AND FEATURES	1
1. Specifications	1
2. Features	1
3. Display	2
4. How to set the time and calendar	2
II. AFTER-SALE SERVICING INSTRUMENTS AND MATERIALS	4
III. CASE	5
IV. DISASSEMBLING, REASSEMBLING, LUBRICATING AND CLEANING	6
1. Liquid crystal panel	6
2. Switch mechanism	8
3. Cleaning	10
V. CHECKING AND ADJUSTMENT	11
1. Guide table for checking and adjustment	11
2. Malfunction and checking points	12
3. Procedures for checking and adjustment	13
A. Check battery voltage	13
B. Check battery conductivity	13
C. Check conductivity of liquid crystal panel, circuit block and connector	13
D. Check bulb condition	15
E. Check switch components	15
F. Check circuit block	18
G. Check current consumption	19
H. Check accuracy	19
• Time accuracy adjusting method	19
I. Check functioning	20

Calibre 0532A

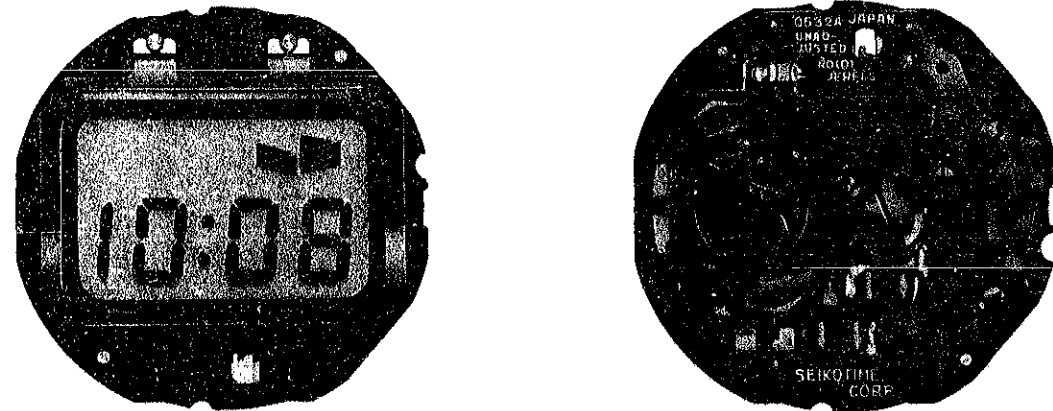

Movement

I. SPECIFICATIONS AND FEATURES

1. Specifications

Item	Calibre No.	0532A
Display medium		Single Crystal Display (Nematic Liquid Crystal, FEM (Field Effect Mode))
Display system		Command system of instant calendar display <ul style="list-style-type: none"> • Time function Hour & minute: 12-hour Digital Display System Second: 10-second unit indicator <ul style="list-style-type: none"> • Calendar function Month & date: 2-second display by turning the crown clockwise or counterclockwise at the normal position
Crystal oscillator		32,768 Hz (Hz = Hertz . . . Cycles per second)
Loss/gain		Loss/gain at normal temperature range Monthly rate: less than 15 seconds (Annual rate: less than 3 minutes)
Casing diameter		φ 27.8 mm (26.0 mm at 6 o'clock ~ 12 o'clock position)
Height		6.8 mm
Operational temperature range		-10°C ~ +60°C (14°F ~ 140°F)
Regulation system		Trimmer condenser
Battery power		Silver oxide battery (U.C.C. 392) Battery life is over one year.
IC (Integrated circuit)		C-MOS-LSI . . . 1 piece

2. Features

Continuous readout in hours and minutes with a 10-second unit indicator, the command system features an instant display of month and date by turning the crown.

Display automatically returns to time function at the end of two seconds. Automatically adjusts date for proper number of days in each month.

Built-in illumination system provides easy readability.

3. Display

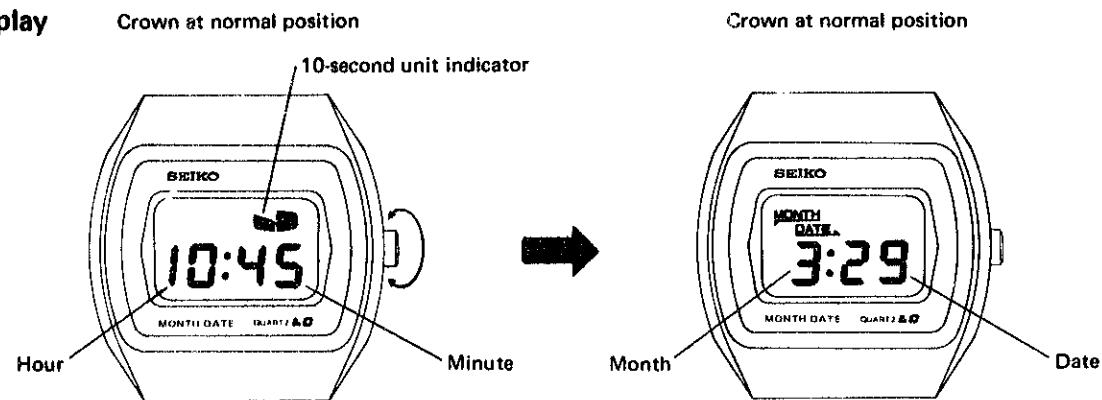

Turn the crown at the normal position either clockwise or counterclockwise and the calendar function digits are displayed for two seconds, after which the time function digits are again displayed automatically.

4. How to set the time and calendar

Pull out the crown from the normal position and the watch is ready to be adjusted. Then, turn the crown clockwise and the digit is selected at each click in the following order.

→ Hour → Minute → Month → Date →

After selecting the digit to be adjusted, turn the crown counterclockwise to adjust the digit.

Example: How to change the indication of 10:45:50 AM of March 29 into 1:05:00 AM of June 10.

(1) Pull out the crown from the normal position

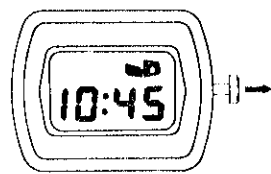

(2) To set the hour digits

With the crown still in the pulled out position, turn the crown clockwise until a click is heard. Then, the hour digits, AM (indicated as A), or PM (indicated as P), and the 10-second unit indicator are only displayed, and other digits are extinguished.

To set the hour digits, turn the crown counterclockwise and one hour is advanced by each click.

Be sure that the time setting is made with the "AM" or "PM" period.

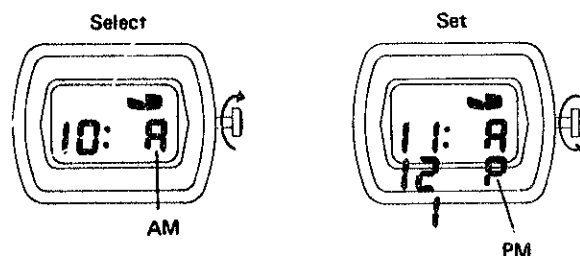

(3) To set the minute digits

With the crown still in the pulled out position, turn the crown clockwise again and the minute digits and 10-second unit indicator are only displayed, and other digits are extinguished.

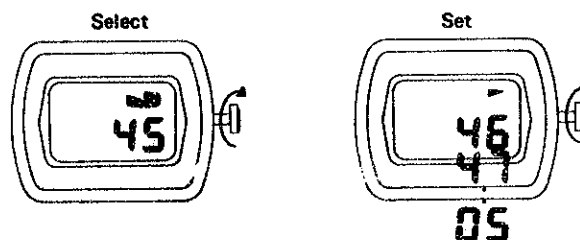

To set the minute digits, turn the crown counterclockwise and one minute is advanced by each click. While the minute digits are being adjusted the watch will stop, and the seconds will reset to "00". (The first segment of the 10-second unit indicator will not blink.) Depress the crown to the normal position to start the watch.

(4) To set the second

Pull out the crown from the normal position, and push it back in with all digits displayed and the 10-second unit indicator will start from "00" second.

However, when the 10-second unit indicator counts any numbers from "00" to "29", the seconds are automatically reset to "00", but when the 10-second unit indicator counts any numbers from "30" to "59", one minute is added and the seconds are immediately reset to "00"

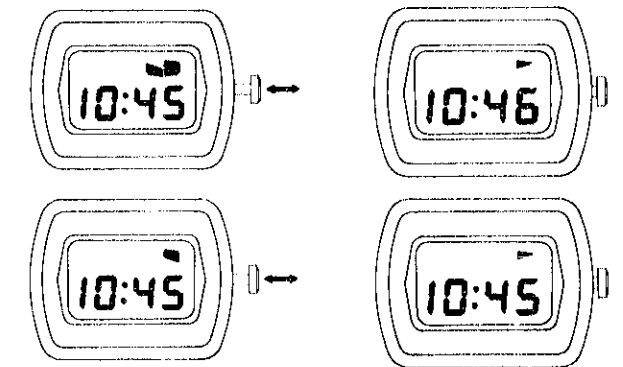

(5) To set the month digits

With the crown still in the pulled out position, turn the crown clockwise three clicks and the month digits are only displayed, and other digits are extinguished.

To set the month digits, turn the crown counterclockwise and one month is advanced by each click.

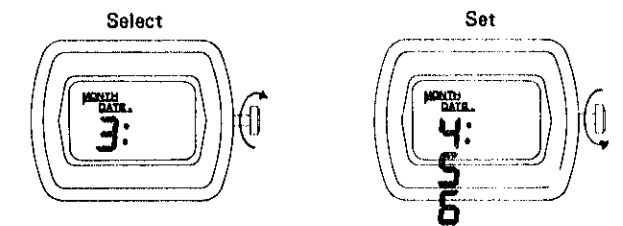

(6) To set the date digits

With the crown still in the pulled out position, turn the crown clockwise again and the date digits are only displayed.

To set the date digits turn the crown counterclockwise and one date is advanced by each click.

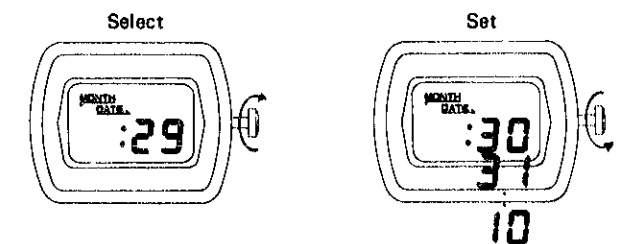

(7) When all the setting procedures are completed, depress the crown to the normal position. The hour, minute and second digits will be displayed and the watch will start from 1:05:00 precisely.

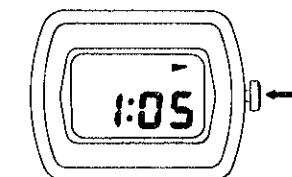

(8) How to use the light

When the crown is at the normal position, depress the crown to activate the illuminating light.

It illuminates the time display in the dark.

Note:

The month, date and hour digits are adjusted independently from the minute digits and the seconds. During adjustment, the minute digits and the seconds advance precisely.

II. AFTER-SALE SERVICING INSTRUMENTS AND MATERIALS

For after-sale servicing of SEIKO Digital Quartz Cal. 0532A, the following after-sale servicing instruments and materials are necessary.

1. Quartz Tester QT-10

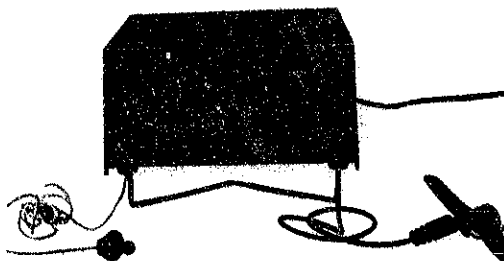

Used to check time accuracy (daily rate).
Use the microphone designed for the liquid crystal watch.

2. Volt-ohm-meter

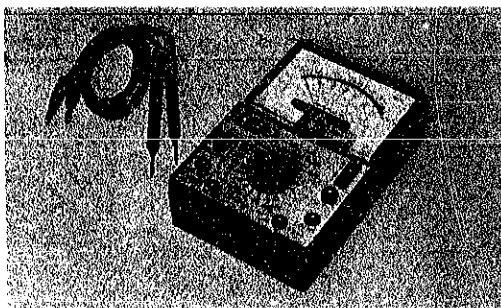

Used to check battery voltage and current consumption.

3. Movement holder S-642

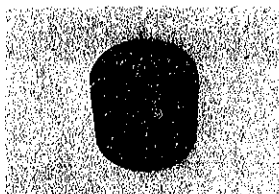

Used for disassembling and reassembling of the movement.
Use the side with the pins when reassembling the switch mechanism. Use the opposite side when reassembling the liquid crystal panel.

4. Battery holding spring S-811



Used for securing battery and flowing current when the movement is removed from the case.

5. Static electricity protector S-830

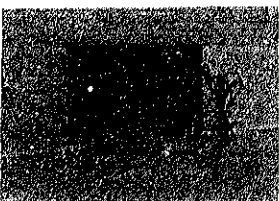

Used to protect the electronic circuit block of Digital Quartz from being damaged by static electricity.

III. CASE

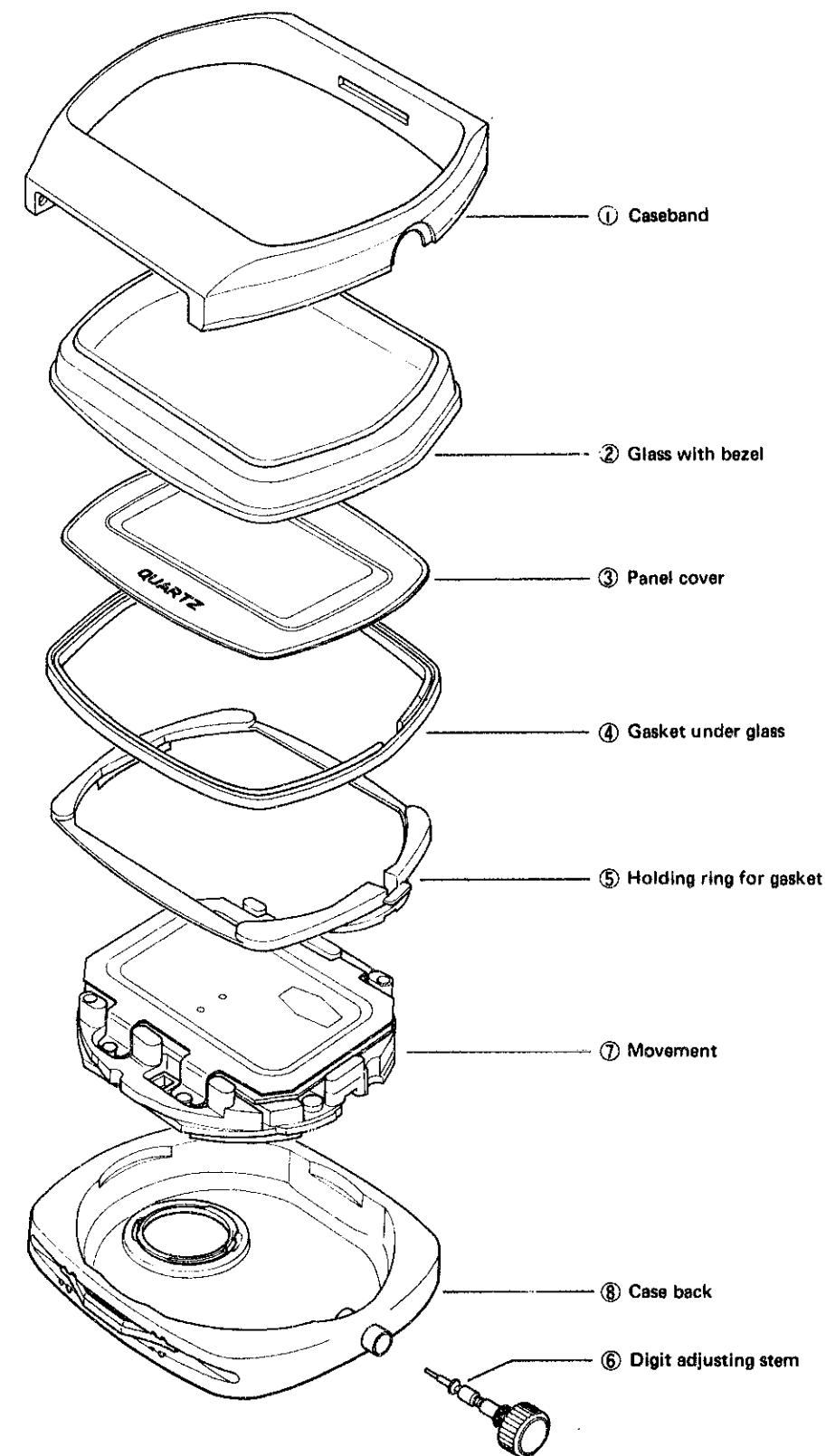

IV. DISASSEMBLING, REASSEMBLING, LUBRICATING AND CLEANING

• Disassembling and reassembling

Disassembling procedures Figs.: ① ~ ②⑥

Reassembling procedures Figs.: ②⑥ ~ ①

1. Liquid crystal panel

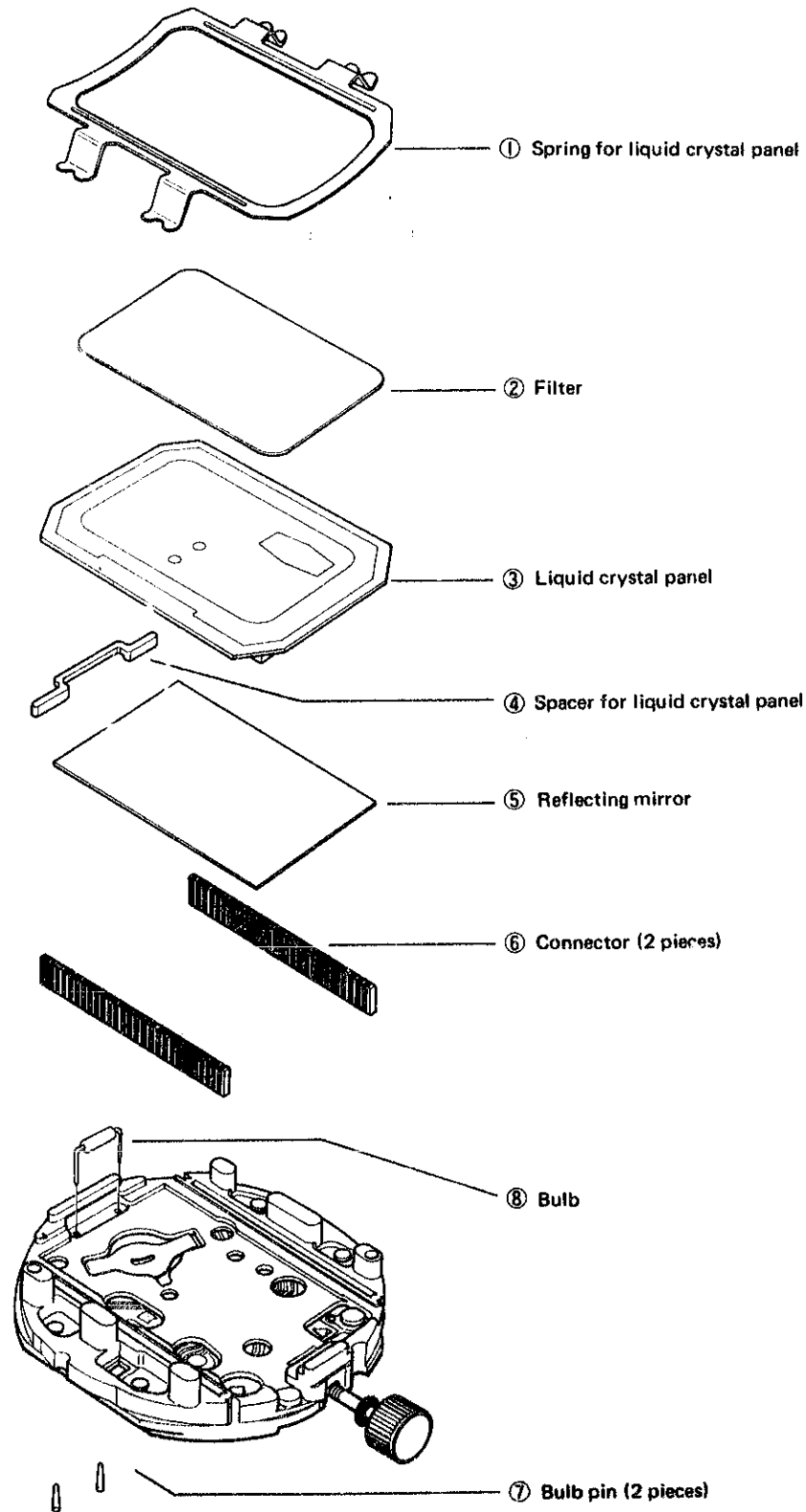

• Type of oil:

∞ SEIKO Watch Oil S-6

• Oil quantity:

∞ Normal quantity

Remarks for disassembling and reassembling

• Disassembling of the spring for liquid crystal panel ①

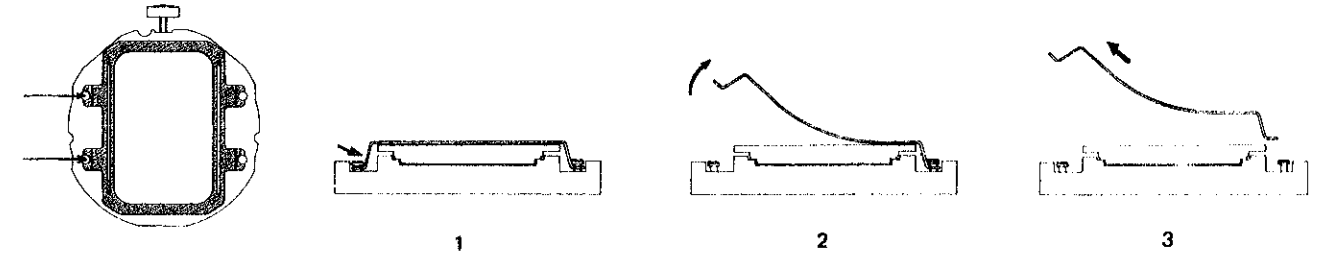

• Liquid crystal panel ③

Use fingercots to disassemble and reassemble the liquid crystal panel. The liquid crystal panel is overlaid with the filter. Usually, it is not necessary to remove the filter.

• Spacer for liquid crystal panel ④

Check to be sure that the spacer for liquid crystal panel is assembled between the circuit block and the liquid crystal panel.

• Reflecting mirror ⑤

Check to see if there is any scratch or foreign matter.

• Connector ⑥

Although two connectors are used but there is no difference between the two. The black portions are conductive. Check to see if there is any scratch or contamination.

• Bulb ⑧

Don't remove the bulb from the circuit block when disassembling the movement. When replacing the bulb with new one, be sure to pull out the bulb pins. (2 pieces)

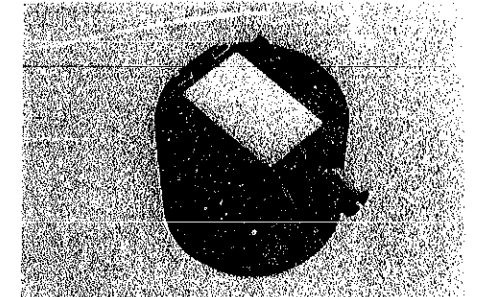

When reassembling the bulb to the circuit block, the bulb must be set apart from the circuit block (as shown in the illustration) and must be set as near the reflecting mirror as possible.



2. Switch mechanism

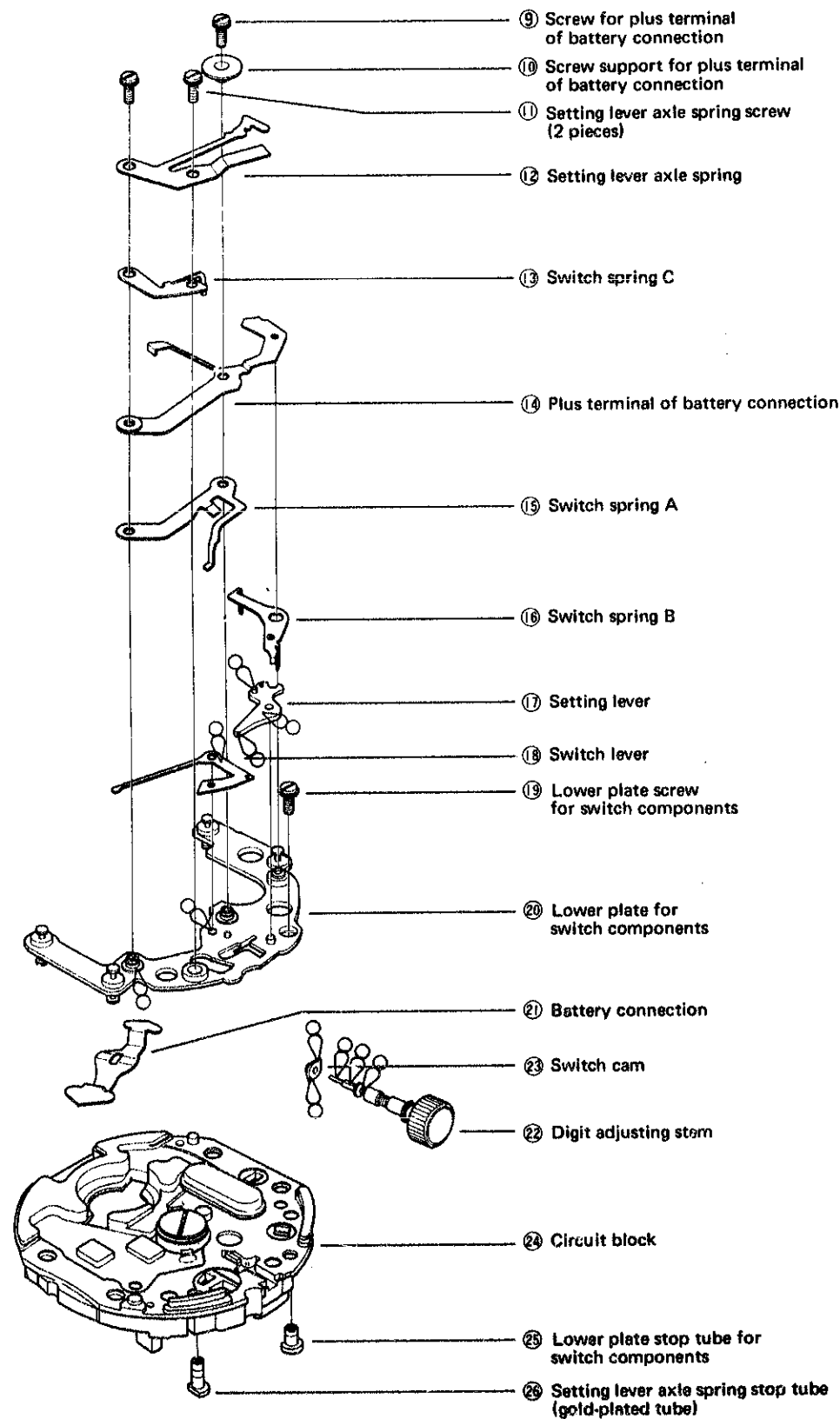
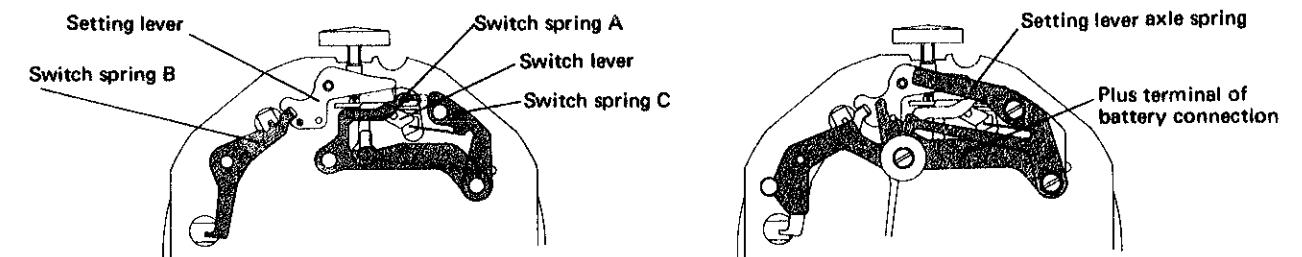

Diagram for reassembling procedures of the setting mechanism



Function of the switch spring

	Connecting portion of the circuit block.	When the crown is pushed from the normal position.	Crown at the normal position.	Crown at the first click position.
Switch spring A			Changeover of the hour and minute digits to the month and date digits by turning the crown clockwise.	Selection of the digits to be adjusted by turning the crown clockwise.
Switch spring B		Portion B touches the circuit block. Light is lit.		Portion A touches the circuit block. Digits are ready to be adjusted.
Switch spring C			Changeover of the hour and minute digits to the month and date digits by turning the crown counterclockwise.	Adjustment of the digits by turning the crown counterclockwise.

• Setting lever axle spring and setting lever axle spring screw ⑪ and ⑫

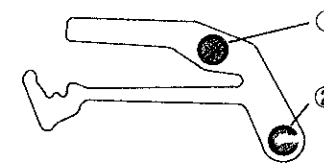

Be sure to check that the switch spring C is set firmly in position and tighten the setting lever axle spring screws in numerical order as illustrated on the left. Otherwise, the digits may not be displayed because of insufficient contact.

• Switch springs, A, B and C, and switch lever ⑬, ⑮, ⑯, and ⑱

Be careful not to bend or damage the thin extended portion of the springs.

• Switch cam ⑳

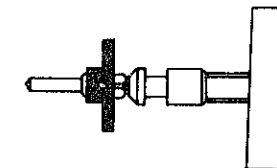

Set the switch cam on the stem so that its flat side is on the crown side as shown in the illustration. If the switch cam is set reversely, the bulb is not lit.

• Lower plate stop tube for switch components and setting lever axle spring stop tube ㉕ and ㉖

When unscrewing the lower plate screw and the setting lever axle spring screw, their stop tube becomes loose and moves out of the circuit block. Be careful not to lose them.

How to set the stop tubes on the movement

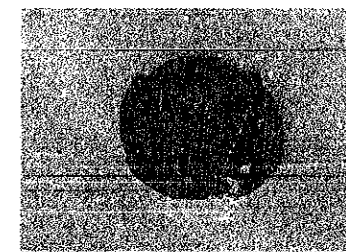

Set the stop tubes into the circuit block.

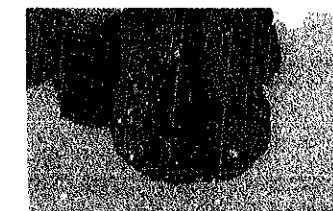



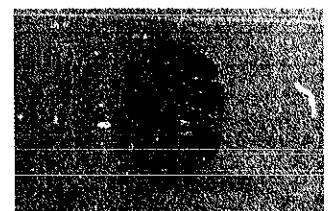

Put the movement holder on the circuit block to set the pins in position.

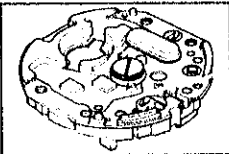
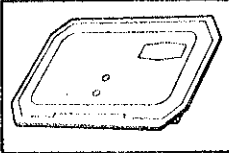

Turn the movement holder upside down in a manner not to let the tube slip off the circuit block.

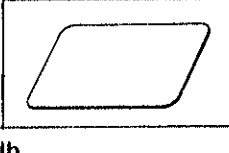
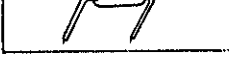
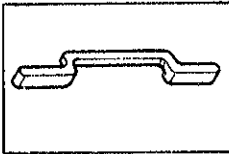
3. Cleaning

Name of parts	Cleaning	Drying	Solution	Remarks
<p>Circuit block</p>  <p>Liquid crystal panel</p>  <p>Reflecting mirror</p>  <p>Filter</p>  <p>Bulb</p> 	DO NOT CLEAN			<ul style="list-style-type: none"> • Clean the conducting portion <u>ONLY</u> with a cloth moistened with benzine, or alcohol, and dry in <u>COOL</u> air. • Wipe dust and lint off with a soft brush.
<p>Spacer for liquid crystal panel</p>  <p>Connector</p> 	Rinse or scrub with a soft brush	Cool air	Alcohol	<ul style="list-style-type: none"> • Clean the connecting portions of the connectors and the liquid crystal panel and the circuit block.
Plastic parts	Rinse or scrub with a soft brush	Cool air	Benzine, alcohol	
Other parts	Clean with cleaner, rinse or wash with a soft brush	Cool or hot air	Benzine, trichloroethylene	

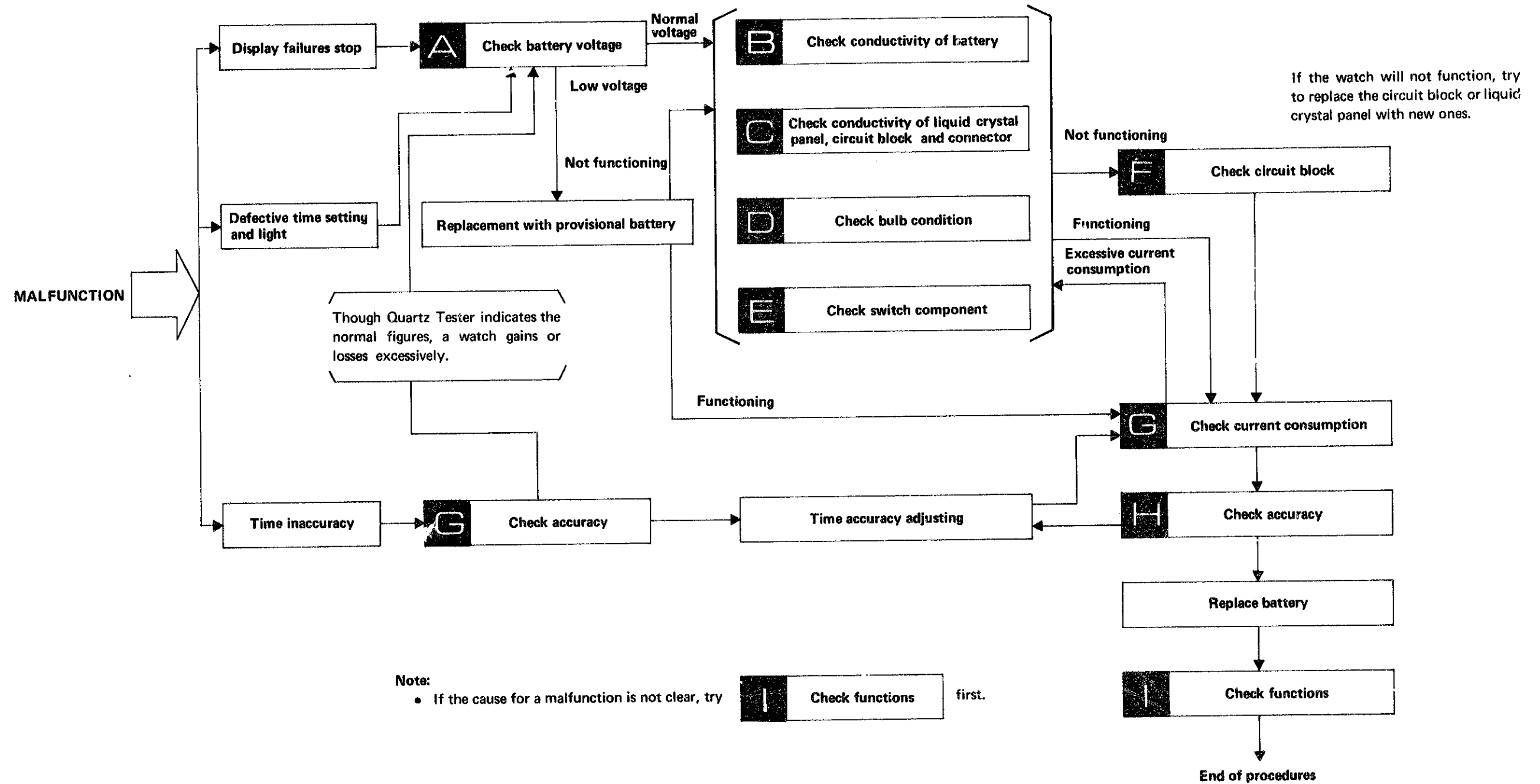

V. CHECKING AND ADJUSTMENT

1. Guide table for checking and adjustment



2. Malfunction and checking points

- Checking in numerical order.
- Refer to "Procedures for checking, and adjustment" on page 13.

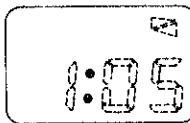
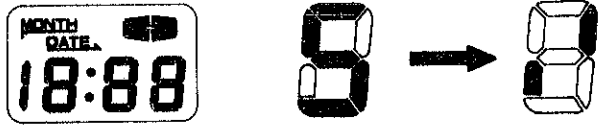
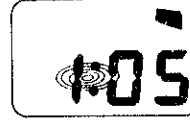
FAULTY SYMPTOMS	CHECKING PORTIONS						
	A	B	C		D	E	F
	Battery	Battery conductivity	Liquid crystal panel	Circuit block	Connector	Bulb	Setting mechanism
<ul style="list-style-type: none"> • Stop. (Though the digits are displayed but do not change or the 10-second unit indicator does not blink.) 	①	②		④			③
<ul style="list-style-type: none"> • No digital display, dim digital display or extremely poor response. 	①	②	④	⑤	⑥		③ ⑦
<ul style="list-style-type: none"> • Some segments of the digital display are not lighted or dim. 			②	③	①		
<ul style="list-style-type: none"> • All digits blink every second. 	①		②	③			
<ul style="list-style-type: none"> • All segments are displayed or the segment which should be on and off are reversed as shown in the illustrations. 			②	③	①		
<ul style="list-style-type: none"> • Some portions of the liquid crystal panel will make black dots or iridescent circles. 			①				
<ul style="list-style-type: none"> • Gain or loss tested by the Quartz Tester. 	①	②					
<ul style="list-style-type: none"> • Though Quartz Tester indicates the normal figures, a watch gains or loses when it is worn on the wrist. 	①	②		③			
<ul style="list-style-type: none"> • Light is not lit or light is lit but dims soon. 	①					②	③
<ul style="list-style-type: none"> • The digits adjusting is impossible or the digital display is extinguished while time adjusting is being made. 				②			①

3. Procedures for checking and adjustment

A CHECK BATTERY VOLTAGE

Use the following procedures to check battery voltage.

- **Set up the Volt-ohm-meter**
Range to be used: DC 3V
- **Measuring**
Probe red (+) Battery surface (+)
Probe black (-) Battery surface (-)
- **Result**
More than 1.5 V Proceed to **B** ~ **H**
Less than 1.5 V Replace the battery with a provisional battery.

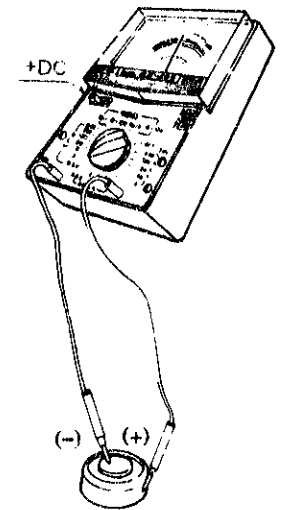

B CHECK BATTERY CONDUCTIVITY

1. **First check**
 - **Check** for any foreign matter on the connecting portion of the battery, battery connection and plus terminal of battery connection.
 - **Result**
Uncontaminated Proceed to **B**₂
Contaminated Wipe off carefully.
2. **Second check**
 - **Make sure** that the screws for plus terminal of battery connection, the lower plate screw for switch components and setting lever axle spring screw are tightened firmly.
 - **Result**
No loosened screw Proceed to **C**
Loosened screw Retighten screw.

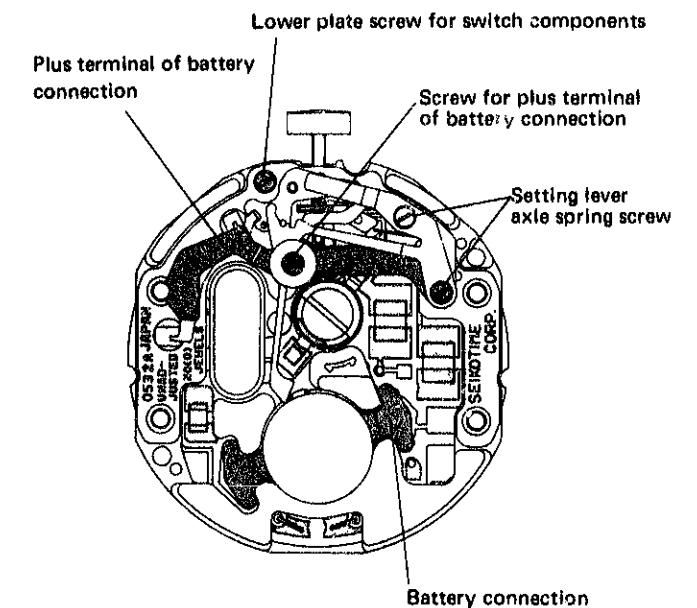

C CHECK CONDUCTIVITY OF LIQUID CRYSTAL PANEL, CIRCUIT BLOCK AND CONNECTOR

Check to see if the conductivity of each connecting portion is normal.

1. **First check**
 - **Check** for stain, crack and tiny break in the connector.
 - **Result**
Normal Proceed to **C**₂
Stained Wipe off carefully with a cloth moistened with alcohol.
Crack or tiny break Replace the connector with a new one.

Check carefully the connecting portions of the liquid crystal panel and the circuit block.

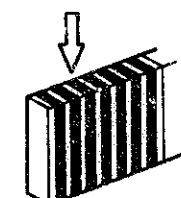

2. Second check

Check the liquid crystal panel electrode (connecting portion of the connector) for any foreign matter and glass defects.

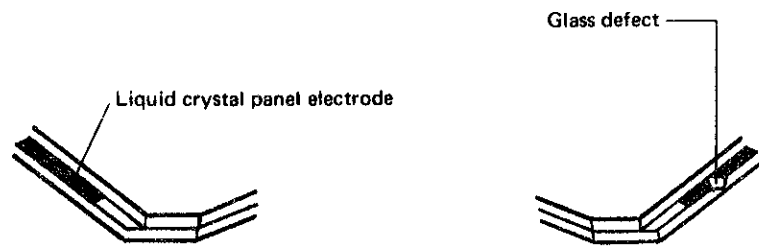

Normal Proceed to **C**₃

Contaminated Wipe off with a cloth moistened with alcohol.

Glass defect Replace the liquid crystal panel with a new one.



Liquid crystal panel electrode (block portion)

3. Third check

Check for any foreign matter on the connecting portion of the circuit block electrode and the connector.

Uncontaminated Proceed to **D**

Contaminated Wipe off with a cloth moistened with alcohol.

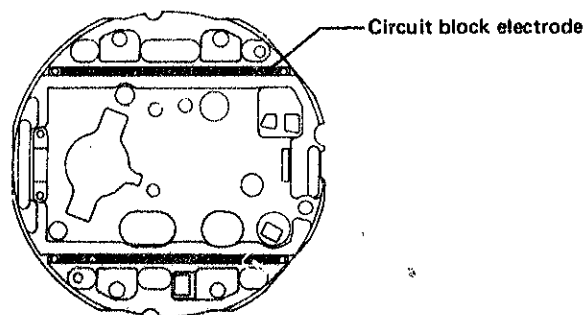

D CHECK BULB CONDITION

Check to see if there is a broken filament in the bulb.

- **Set up the Volt-ohm-meter**

Range to be used: OHMS R x 1

- **Checking**

Apply the probes (Either red or black probe will do) to the two terminals of the bulb.

- **Result**

Light is lit Proceed to **E**

Light is not lit Replace the bulb with new one.



E CHECK SWITCH COMPONENTS

Check to see if each switch functions correctly.

1. First check

- **Check** for any foreign matter on the switch springs (A), (B) and (C).

- **Result**

Uncontaminated Proceed to **E**₂

Contaminated Wipe off carefully.

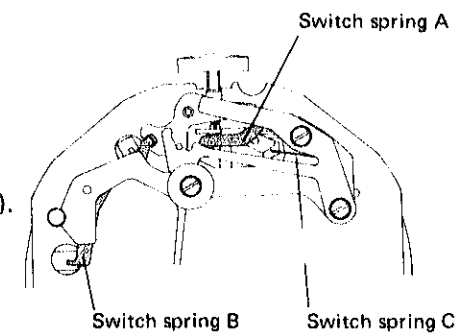

2. Second check

- **Check** to see if the switch springs (A), (B) and (C) are set in the correct positions. Check the connecting portion of each switch and the circuit block.

- **Check the switch spring A**

Check the switch spring A from the liquid crystal panel side.

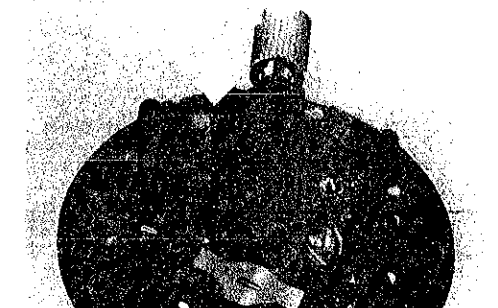
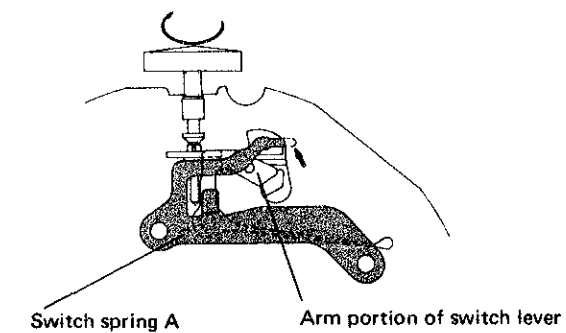

Turn the crown clockwise at the normal position or at the first click position and the switch lever arm will be raised by the switch cam, and the tip (arrow marked) of the switch spring A will touch the lead pattern of the circuit block instantaneously. This touch will instantaneously change the time digits into the calendar digits if the crown is at a normal position. If the crown is at the first click position, any digits to be adjusted can be selected.

• **Result**

The switch spring A touches the circuit block by turning the crown clockwise.

..... Proceed to check the switch spring B.

The switch spring A does not touch the circuit block or sticks to the circuit block when turning the crown clockwise. Correct the arrow marked portion of the switch spring A with tweezers.

• **Check the switch spring B**

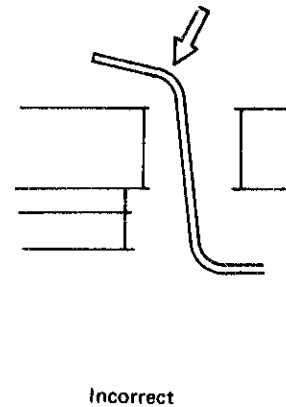
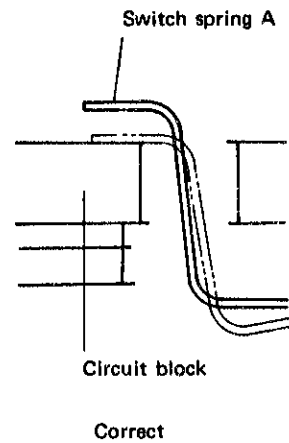

• **Crown position: Normal**

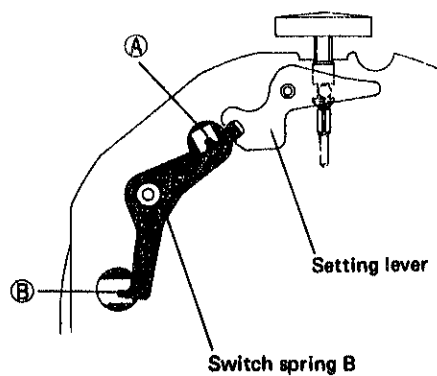

Neither A nor B portion of the switch spring B touch the circuit block.

• **Crown position: First click**

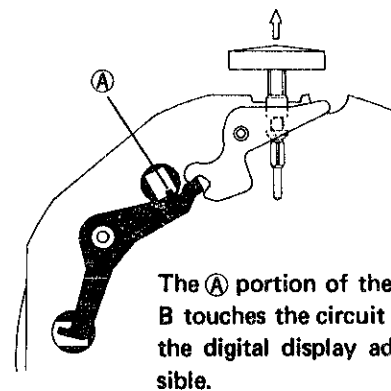

The A portion of the switch spring B touches the circuit block, making the digital display adjustment possible.

• **Crown position: Pushed-in**

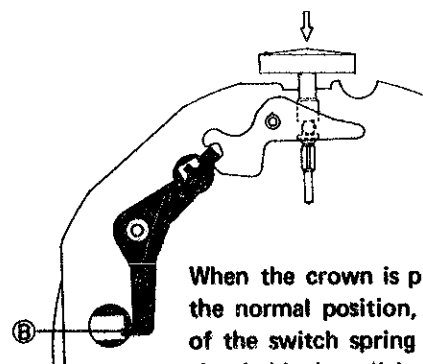

When the crown is pushed in from the normal position, the B portion of the switch spring B touches the circuit block to light the illuminating light.

• **Result**

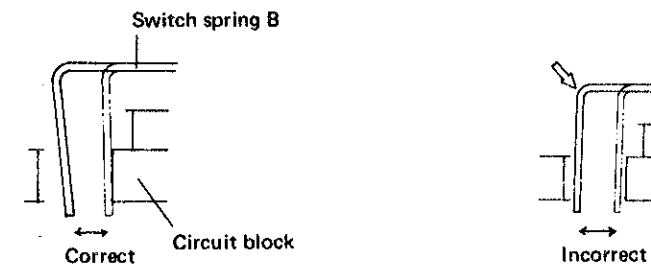

When the crown is pulled out to the first click or pushed in from the normal position, the switch spring B touches the circuit block correctly. Proceed to check the switch spring C.

When the crown is pulled out to the first click or pushed in, the switch spring B does not touch the circuit block, or the switch spring B touches the circuit block with the crown at the normal position.

..... Correct the arrow marked portion of the switch spring B with tweezers.

• **Check the switch spring C**

Crown position: Normal and first click

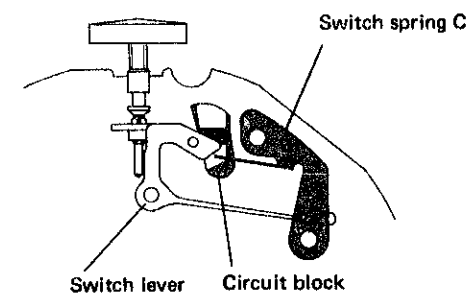

A clearance must be provided between the switch spring C and the circuit block.

Counterclockwise turn of the crown

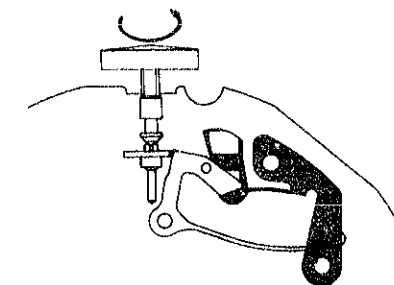

The switch spring C touches the circuit block and changeover of the time digits to and from calendar digits (with the crown at the normal position) or adjustment of the selected digits (with the crown at the first click position) are possible.

• **Result**

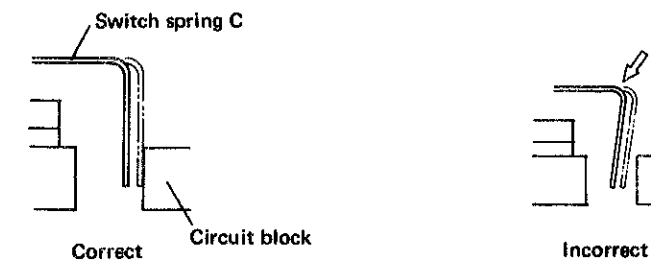

• When the crown is at the normal position and first click position, there must be a clearance between the switch spring C and the circuit block. When the crown is turned counterclockwise, the switch spring C touches circuit block.

Proceed to



• When the crown is turned counterclockwise, the switch spring C does not touch the circuit block or the switch spring C touches the circuit block without turning the crown counterclockwise.

..... Correct the arrow marked portion of the switch spring C with tweezers.

F CHECK CIRCUIT BLOCK

Check to see if the electric signal flows from the circuit block to the liquid crystal panel.

1. Put the battery into the movement and secure it with the battery holding spring.
2. Remove the spring for liquid crystal panel, the filter and the liquid crystal panel according to the disassembling procedures.
3. Set up the Volt-ohm-meter
Range to be used: DC 3 V
4. Measuring
Probe red (+) Crown or digit adjusting stem
Probe black (-) Black portion of the connector

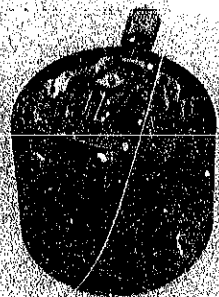

How to hold the battery

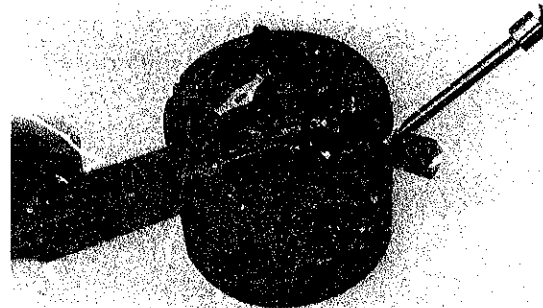

How to apply the probes

5. Result.

The pointer moves watch operates Proceed to **G**
 watch does not operate Replace the liquid crystal panel with a new one.

The pointer does not move Replace the circuit block with a new one.

Remarks:

1. The voltage indicated by the pointer of the Volt-ohm-meter must always be kept constant so long as any black portion of the connector is touched by the probe. (The voltage must be between 1.0 V ~ 1.4 V by using the Volt-ohm-meter (AF-105). If the voltage is not constant, replace the circuit block with a new one. The other calibres whose circuit block can be checked with this method are Cal. 0124 and 06 series.
2. Touch the connector lightly with the probes.

G CHECK CURRENT CONSUMPTION

Check to see if the current consumption is normal.

1. Set up the Volt-ohm-meter
Range to be used: DC 0.03 mA
2. Measuring
Probe red (+) Battery connection
Probe black (-) Battery surface (-)

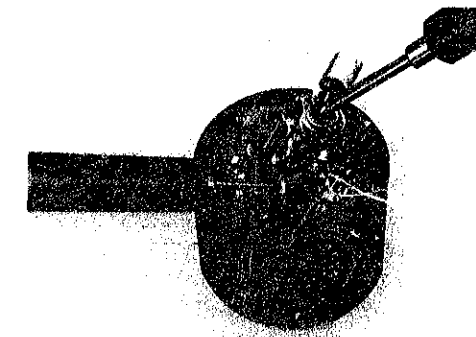

Place the battery on the setting lever axle spring or the plus terminal of battery connection with its minus surface turned up.

H CHECK ACCURACY

Check gain and loss of time.

1. Set up the Quartz Tester
Use the electric-field detection microphone for the liquid crystal watch.

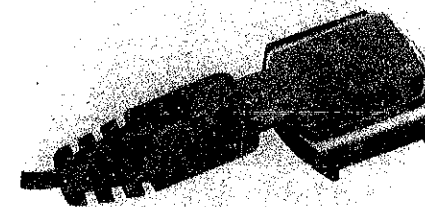

Time accuracy adjusting method

Time accuracy is adjusted by turning the trimmer condenser.

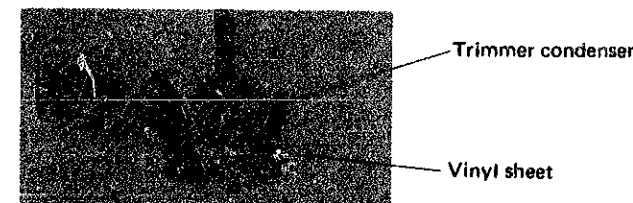

When measuring the timing accuracy of the movement with the electric field detection microphone, follow the procedures below.

1. Place a vinyl sheet between the liquid crystal panel face and the microphone.
2. Place the movement so that the microphone spring touches the battery or the battery holding spring.
3. Measurement is made while the level adjuster is in the AUTO position. But, in case the input indicator has ceased to be lit or is blinking irregularly while measuring, this is due to the faint signal levels caused by the variations in digital indications of the watch. In such a case, turn the level adjuster. (Insert the earphone jack and measurement must be made when the noise becomes the loudest).

CHECK FUNCTIONING

Check to see if each time setting function works correctly by crown operation.

Note:

Incomplete digital figures may show on the display panel after battery replacement. However, this is not a malfunction. Should this occur pull out the crown to the first click and push it back to normal position. Next correct the digital display figures of each segment of the display panel as mentioned previously in the adjusting method of hour, minute, month and date. Use the following procedures to check the functioning.

1. First check

With the crown in the pulled out position, turn it clockwise and counterclockwise to check if the hour, minute, month and date digits can be selected and adjusted correctly, and also check to see if there is any segment which is not lit.

2. Second check

Pull out the crown from the normal position and then push in to check if the second will reset to "00" second.

When the 10-second unit indicator counts any number from "00" to "29" the seconds are reset to "00" automatically whenever the crown is depressed. When the 10-second unit indicator counts "30" to "59" and the crown is depressed, one minute is added and the seconds immediately return to "00".

3. Third check

Depress the crown at the normal position and make sure that the light is lit.

All procedures of Disassembling, Reassembling, Checking and Adjustment are completed.