

SEIKO LASSALE

QUARTZ

Cal. 1230A

PARTS CATALOGUE

Cal. 1230A



125 126



139 121



231 122



261 121



☆ 270 126



☆ 271 126



281 121



282 122



☆ 351 117



383 121



384 121



388 120



391 121



491 122



493 130



4001 299



4002 121



4146 121



4219 120



4219 121



4239 121



4270 120



4271 120



4408 121



4408 122



4446 120



SEIKO TR616SW



012 490



012 792



012 796



017 556



017 558



017 586



017 642



017 643



017 644



017 645



017 647

2/1

Cal. 1230A

Characteristics

Casing diameter : 15.1 × 13.0 mm
 Maximum height : 1.9 mm without battery
 Jewels : 2 j
 Frequency of quartz crystal oscillator : 32,768 Hz (Hz=Hertz Cycles per second)
 Driving system : Step motor (2 poles)
 Regulation system : Trimmer condenser
 Train wheel setting

PART NO.	PART NAME	PART NO.	PART NAME
125 126	Train wheel bridge	017 647 SEIKO TR616SW Maxell SR616SW	Tube for coil block Silver (II) oxide battery Silver oxide battery
139 121	Lower bridge for third wheel		
231 122	Third wheel & pinion		
261 121	Minute wheel		
☆270 126	Center minute wheel with cannon pinion		
☆270 128			
☆271 126			
☆271 128	Hour wheel		
281 121	Setting wheel		
282 122	Clutch wheel		
☆351 117	Winding stem		
383 121	Setting lever		
384 121	Yoke (Clutch lever)		
388 120	Setting lever spring		
391 121	Train wheel setting lever		
491 122	Dial spacer		
493 130	Hour wheel ring (Gold, 0.03 mm thickness)		
493 131	Hour wheel ring (Silver, 0.05 mm thickness)		
493 132	Hour wheel ring (Gold, 0.07 mm thickness)		
4001 299	Circuit block		
4002 121	Coil block		
4146 121	Step rotor		
4219 120	Battery connection insulator (A)		
4219 121	Battery connection insulator (B)		
4239 121	Rotor stator		
4270 120	Battery connection (-)		
4271 120	Battery connection (+)		
4408 121	Setting lever spring spacer		
4408 122	Dial spacer		
4446 120	Crystal unit cushion		
011 409	Upper hole jewel for step rotor		
011 541	Lower hole jewel for step rotor		
012 490	Train wheel bridge screw		
012 490	Coil block screw		
012 792	Circuit block screw		
012 796	Setting lever spring screw		
012 796	Screw for lower bridge for third wheel		
017 556	Tube for yoke		
017 558	Tube for lower bridge for third wheel		
017 586	Minute wheel pin		
017 642	Tube for train wheel bridge (A)		
017 643	Tube for train wheel bridge (B)		
017 644	Tube for circuit block (A)		
017 645	Tube for circuit block (B)		

☆⇔Please see remarks on the reverse page.
 Part numbers in light letters are not shown in photos.



Cal. 1230A

Remarks :

Center minute wheel with cannon pinion, Hour wheel

There are two different types as specified below.

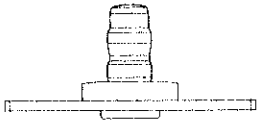
Combination :

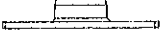
Type.	Center minute wheel with cannon pinion	Hour wheel
a	 <p>☆270 126</p>	 <p>☆271 126</p>
*b	 <p>☆270 128</p>	 <p>☆271 128</p>

☆As of this printing the type b combination is not used.
 However it may be employed in the future with certain case designs.

Winding stem

☆351 117.....Refer to the photograph on the front page.
 If the combination of the winding stem and case is unknown, check the case number and refer to "SEIKO LASSALE Quartz Casing Parts Catalogue" to choose a corresponding winding stem.

TECHNICAL GUIDE

SEIKO
LASSALE

QUARTZ

CAL. 1230A

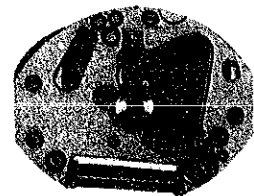

CONTENTS

I. SPECIFICATIONS	1
II. DISASSEMBLING, REASSEMBLING AND LUBRICATING	2
1. ① Hour and minute hands ~ ⑩ Center minute wheel with cannon pinion	2
2. ⑪ Coil block screw ~ ⑲ Crystal unit cushion	3
3. ⑳ Train wheel bridge screw ~ ㉿ main plate	4
III. CHECKING AND ADJUSTMENT	5
1. Structure of circuit block	5
2. Checking and Adjustment	5
• Check output signal	5
• Check battery voltage	5
• Check battery conductivity	6
• Check circuit block conductivity	6
• Check coil block	6
• Check reset and train wheel setting condition	6
• Check gear train mechanism	7
• Check setting mechanism	7
• Check current consumption	7
• Check time accuracy	8
• Check water resistance	8
• Check appearance and functioning	8

I. SPECIFICATIONS

Item	Cal. No.	1230A
Time indication		2-hand (Moves at every 20 seconds)
Additional mechanism		Train wheel setting device Electronic circuit reset switch
Loss/gain		Loss/gain at normal temperature range Monthly rate: less than ± 15 seconds
Outside diameter		15.5 mm between 12 o'clock and 6 o'clock sides 13.0 mm between 3 o'clock and 9 o'clock sides
Casing diameter		ϕ 15.1 mm
Height		1.9 mm
Regulation system		Trimmer condenser
Measuring gate by Quartz Tester		Use the gate of 10 seconds
Battery		SEIKO (SEIZAIKEN) TR616SW Battery life is approximately 3 years. Voltage: 1.55 V
Jewels		2 jewels

II. DISASSEMBLING, REASSEMBLING AND LUBRICATING

Disassembling procedures: Fig. ① → ③④

Reassembling procedures: Fig. ③④ → ①

Lubricating

Type of oil	Oil quantity
● Maebius A	● Normal
○ SEIKO Watch Oil S-6	● Extremely small

• Use the movement holder S-664 for reassembling and disassembling

1. ① Hour and minute hands ~ ⑩ Center minute wheel with cannon pinion

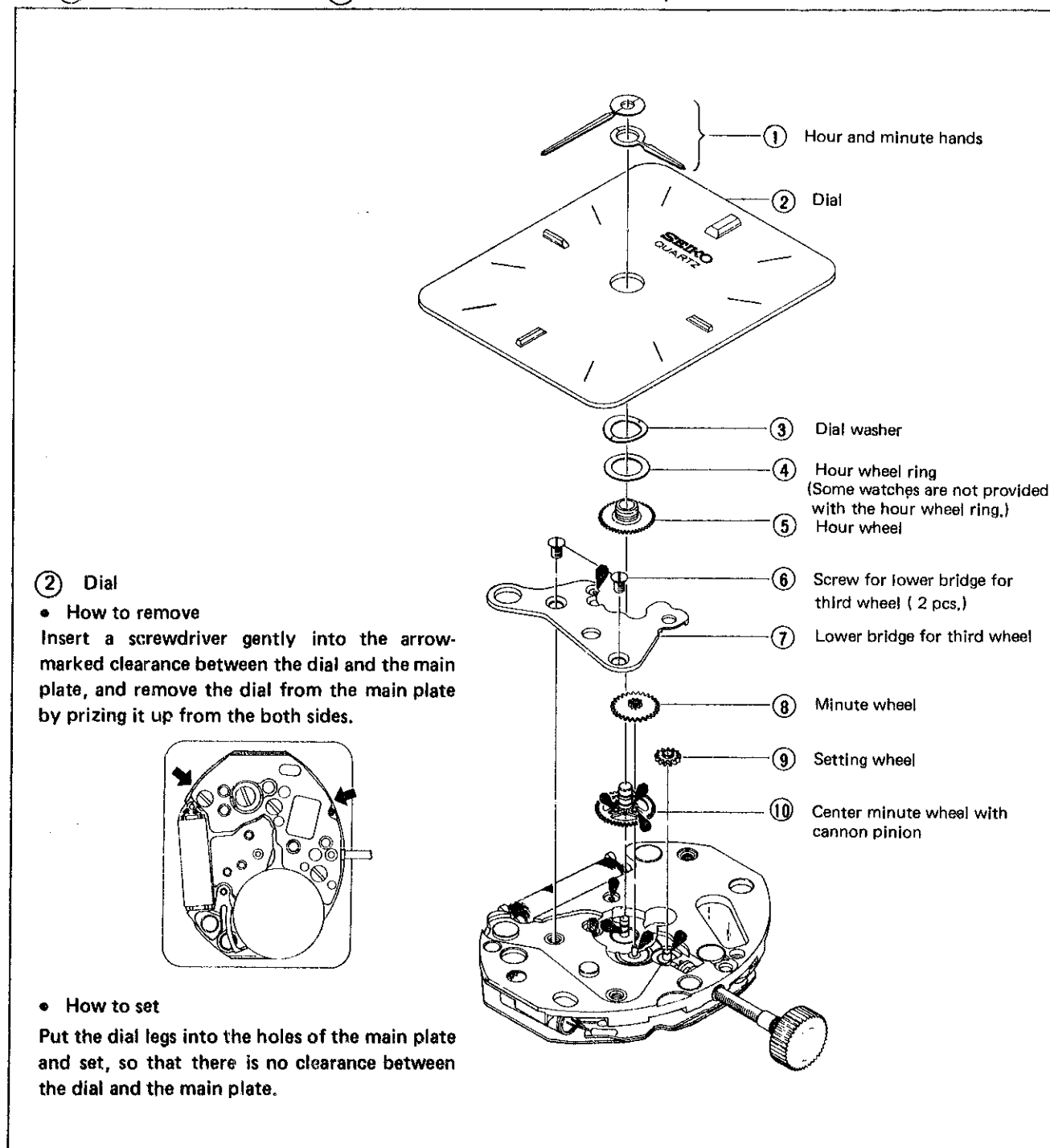

2. ⑪ Coil block screw ~ ⑲ Crystal unit cushion

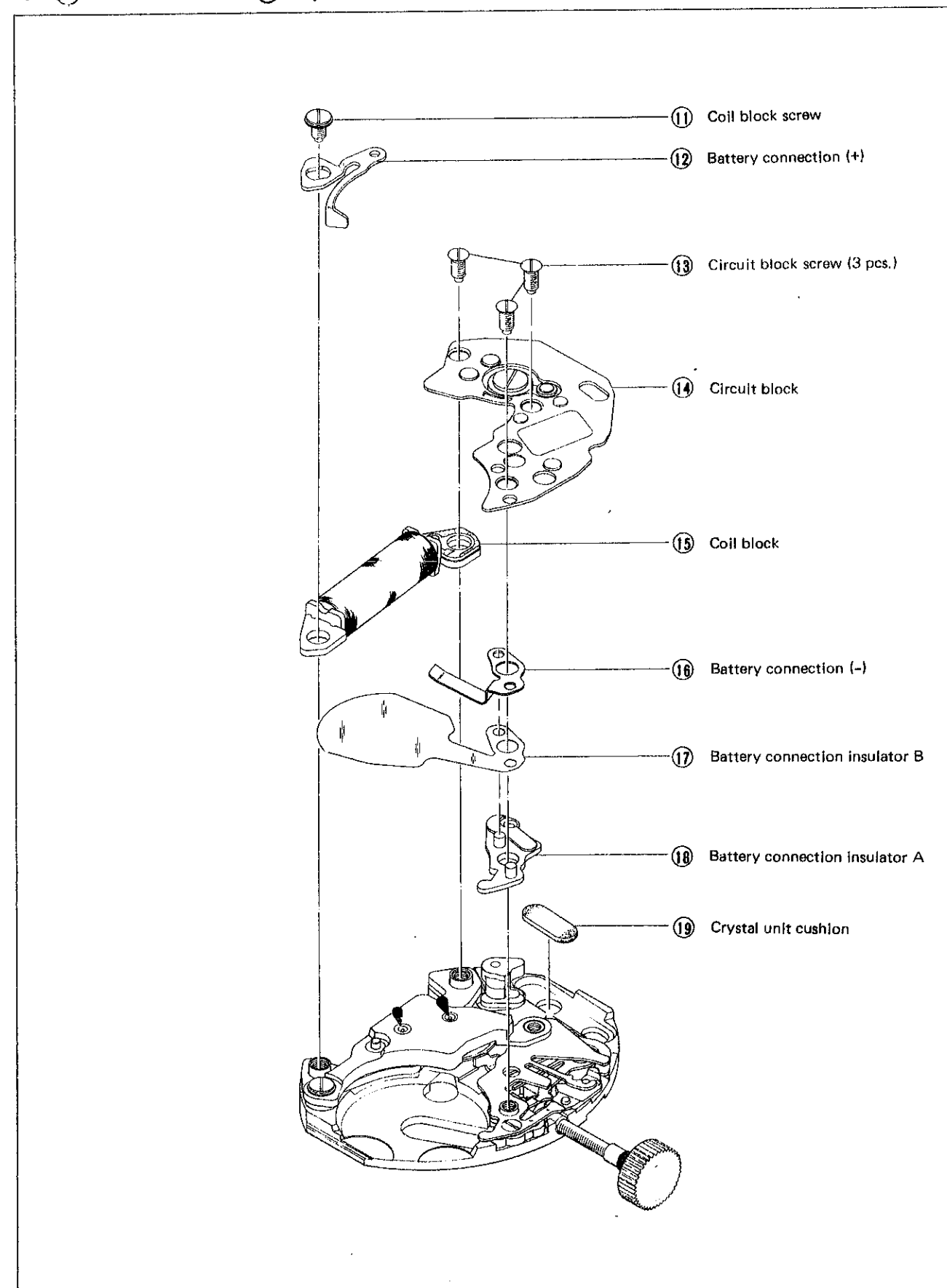

3. (20) Train wheel bridge screw ~ (34) main plate

• Setting position of the gear train

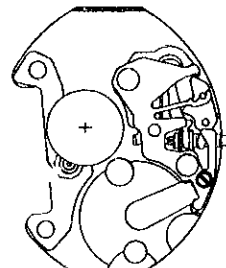

Front View

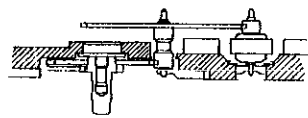

Side View

• Setting-up from figure (27) train wheel setting lever to (34) main plate

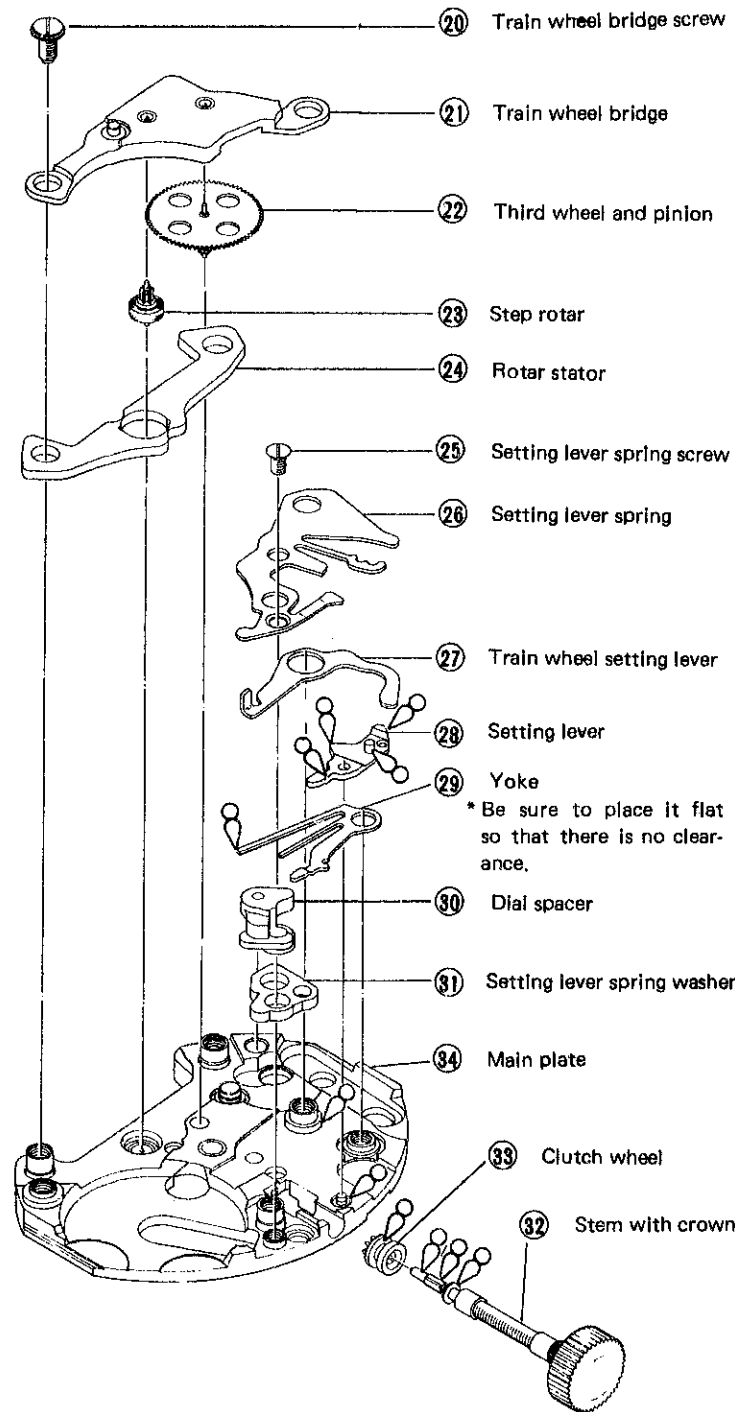
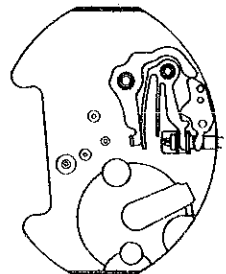

III. CHECKING AND ADJUSTMENT

1. Structure of circuit block

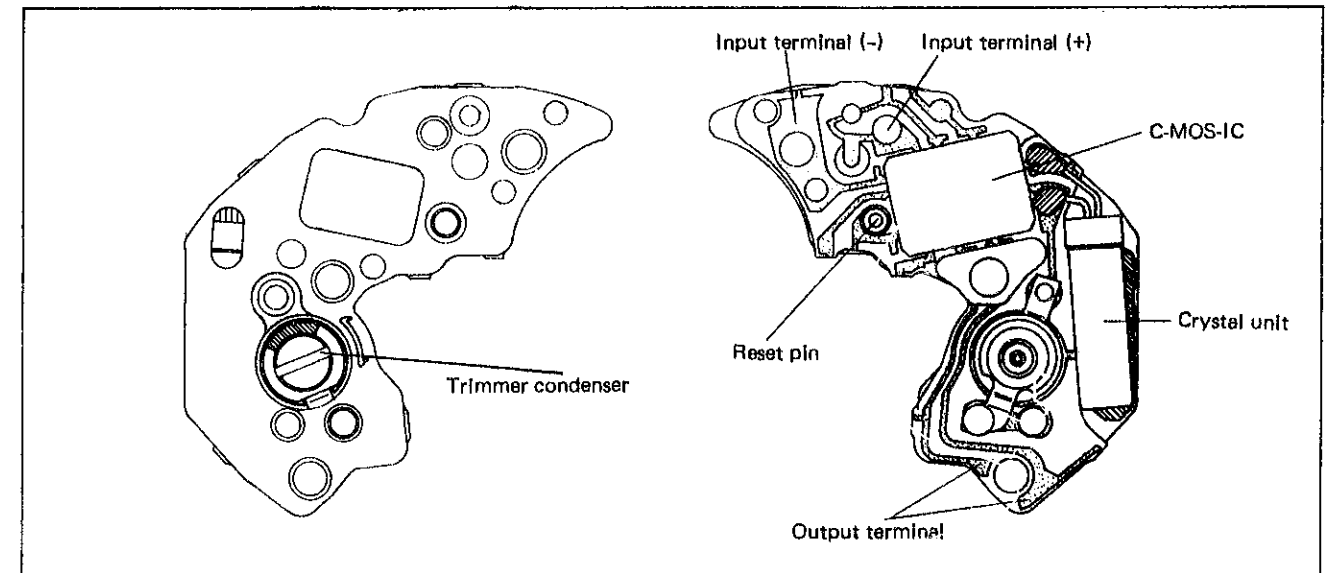

2. Checking and adjustment

- Refer to the "SEIKO QUARTZ TECHNICAL GUIDE, GENERAL INSTRUCTION FOR ANALOGUE WATCHES" for details.

Procedure	
CHECK OUTPUT SIGNAL	<p>Result:</p> <p>Normal : Input indicator blinks every 10-second</p> <p>Defective : Input indicator does not blink every 10-second</p>
CHECK BATTERY VOLTAGE	<p>Range to be used: D.C. 3 V</p> <p>Result:</p> <p>Normal : More than 1.5V</p> <p>Defective : Less than 1.5V Replace the battery.</p>

Procedure

Remarks for measuring the current consumption

- As for Cal. 1230A watches, the second hand moves at 20-second intervals. That's why the pointer of the Volt-ohm meter swings once every 20 seconds when measuring the current consumption.
- When the probes (+) and (-) of the Volt-ohm meter are applied to the watch as shown in the illustration above, the pointer swings slightly, indicating that the current is flowing through the IC. After this, a larger swing of the pointer continues at 20-second intervals. This indicates that in addition to the current flowing through the IC, the motor driving current is flowing.
- The current consumption is calculated as follows.

[Example]

Assume the following formulas;

$$\text{IC current} = 0.25\mu\text{A}$$

and

$$\text{IC current} + \text{motor driving current} = 0.8\mu\text{A}$$

From the formulas above, the current necessary for driving the motor alone is $0.55\mu\text{A}$. This, however, is a value when the second hand moves at 20-second intervals. Therefore, to obtain the current consumption it is necessary to convert this value into the one measured at one-second intervals.

So, reduce the value $0.55\mu\text{A}$ to $1/20$ to get $0.03\mu\text{A}$ of the current consumption necessary for the motor alone.

Accordingly, the value of current consumption for this watch is;

$$0.25\mu\text{A} + 0.03\mu\text{A} = 0.28\mu\text{A}$$

CHECK TIME ACCURACY

Use the gate of 10-second.

CHECK WATER RESISTANCE

CHECK APPEARANCE AND FUNCTIONING