

Cal. 4006A

Characteristics

Casing diameter: 31.20^h mm
 Maximum height: 7.15 mm
 Vibrations per hour: 19,800
 Automatic winding with sweep second
 Calendar (day & date)
 Instant date change
 Alarm device
 "Diashock" Shock Resistant Device

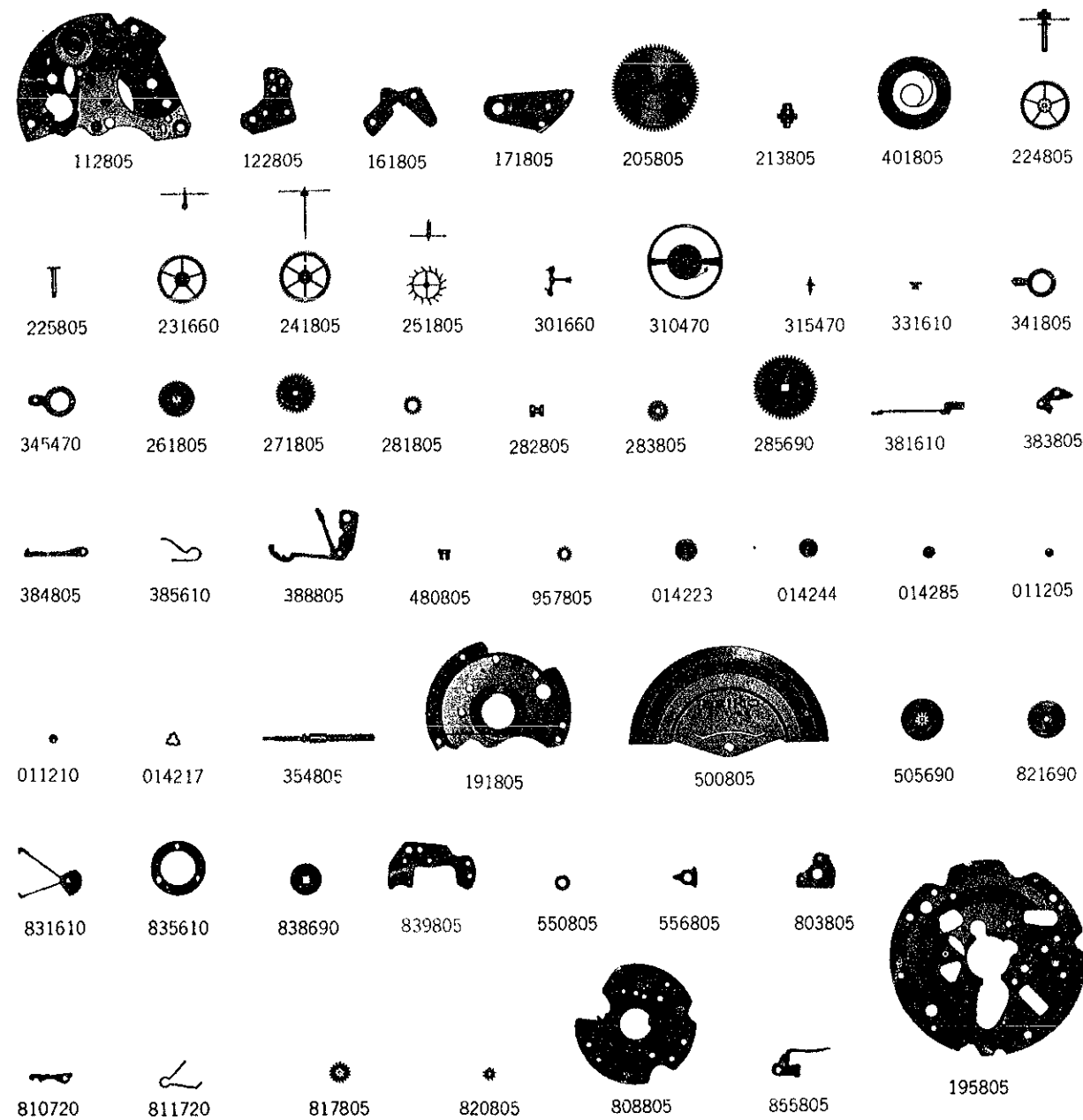

— continued on next page —

— continued —

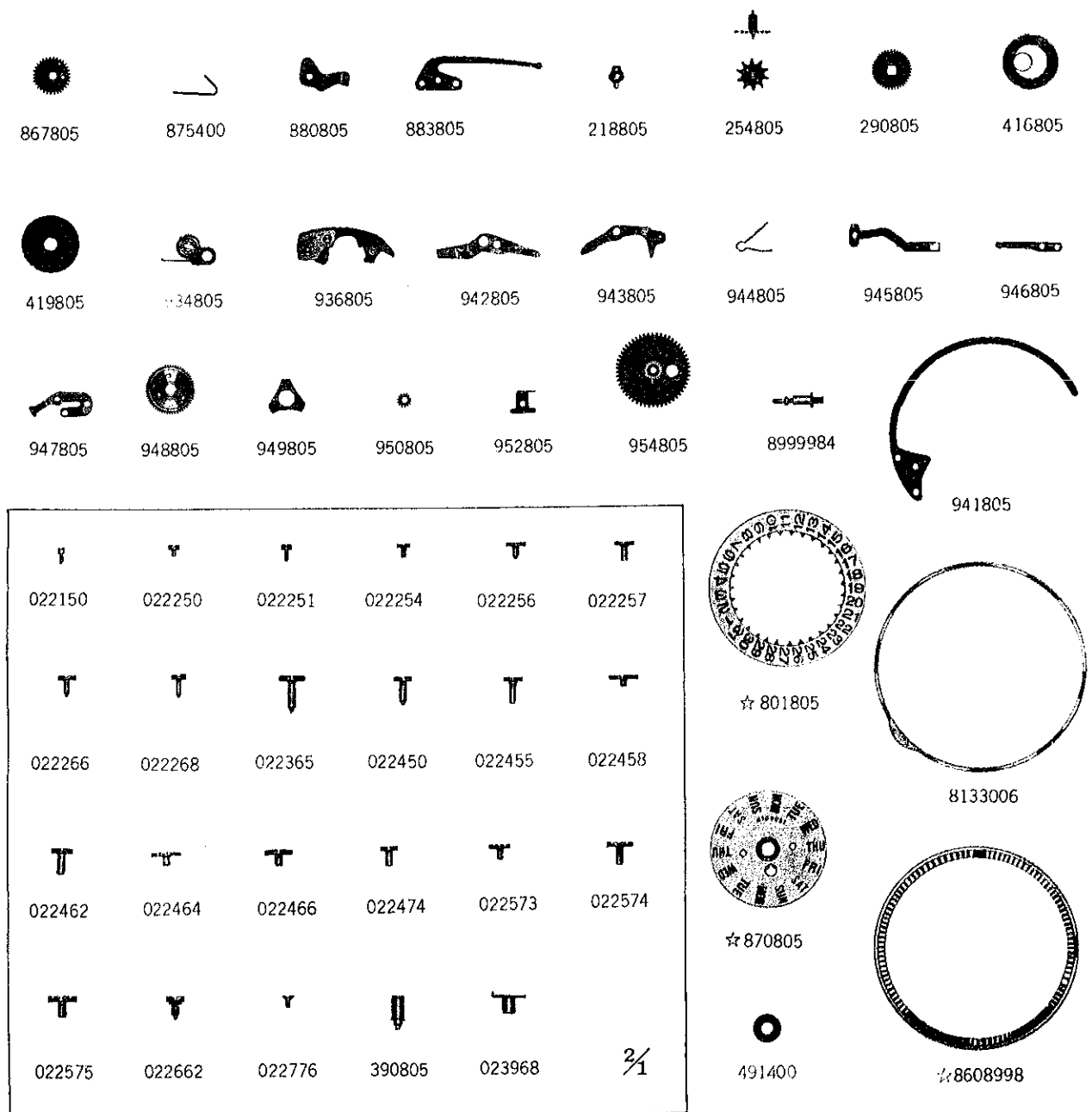

☆ ⇨ Please see remarks on the next reverse page.

Calibre No. 4006A		Jewels 27j	Style Name (Bell Matic)	
PART NO.	LIST OF MATERIALS	PART NO.	LIST OF MATERIALS	
112805	Barrel & train-wheel bridge	867805	Day & date driving wheel	
122805	Center wheel bridge	☆870805	Day star with dial disk	
161805	Pallet cock	875400	Setting wheel lever spring	
171805	Balance cock	880805	Date corrector	
191805	Framework for automatic device	883805	Date corrector spring	
195805	Calendar plate	218805	Alarm barrel arbor	
205805	Complete barrel with arbor	254805	Alarm wheel	
213805	Barrel arbor	290805	Alarm ratchet wheel	
224805	Center wheel & pinion with cannon pinion	416805	Alarm mainspring (self-greasing)	
		419805	Alarm mainspring seat	
225805	Cannon pinion	934805	Intermediate wheel rocker for alarm	
231660	Third wheel & pinion	936805	Alarm hammer	
241805	Sweep second wheel & pinion	941805	Sounding spring	
251805	Escape wheel & pinion	942805	Alarm bolt yoke	
261805	Minute wheel	943805	Alarm setting lever	
271805	Hour wheel	944805	Alarm bolt yoke spring	
281805	Setting wheel	945805	Disconnecting lever	
282805	Clutch wheel	946805	Disconnecting lever spring	
283805	Winding pinion	947805	Alarm setting lever spring	
285690	Ratchet wheel	948805	Unlocking wheel	
301660	Jewelled pallet fork & staff	949805	Friction spring for unlocking wheel	
310470	Balance complete with stud	950805	Intermediate unlocking wheel	
315470	Balance staff	952805	Alarm setting wheel holder	
331610	Roller with jewel	954805	Intermediate alarm setting wheel	
341805	Regulator	022150	Stud screw	
345470	Stud holder	022250	Holder screw for transmission wheel & pawl lever	
354805	Winding stem			
381610	Click	022251	Click screw	
383805	Setting lever	022254	Disconnecting lever spring screw	
384805	Yoke (Clutch lever)	022256	Pallet cock screw	
385610	Yoke spring (Clutch lever spring)	022257	Center wheel bridge screw	
388805	Setting lever spring	022257	Setting lever spring screw (Cheese-head screw)	
390805	Setting lever axle			
401805	Mainspring with slipping attachment	022257	Date corrector spring screw	
480805	Setting wheel ring	022257	Calendar plate screw	
491400	Dial washer	022257	Alarm setting lever spring screw	
957805	Intermediate minute wheel	022266	Alarm setting wheel holder screw	
014223	Diashock upper frame	022268	Framework screw for automatic device	
014244	Diashock lower frame			
014285	Diashock hole jewel with frame	022365	Sounding spring screw	
011205	Diashock upper cap jewel	022450	Bridge screw	
011210	Diashock lower cap jewel	022455	Dial screw	
014217	Diashock spring	022458	Screw for oscillating weight	
500805	Oscillating weight	022462	Ratchet wheel screw	
505690	Transmission wheel	022464	Alarm bolt yoke screw	
821690	Ball-bearing for oscillating weight	022466	Intermediate wheel rocker screw for alarm	
831610	Pawl lever with jewel			
835610	Ball-bearing holder	022474	Date dial guard screw	
838690	Pawl lever seat	022573	Screw for day & date driving wheel	
839805	Holder for transmission wheel & pawl lever	022574	Setting wheel lever screw	
		022575	Alarm ratchet wheel screw	
550805	Date finger washer	022662	Setting lever spring screw (Step screw)	
550805	Setting wheel rocker washer			
556805	Date finger			
☆801805	Date dial	022776	Ball-bearing holder screw	
803805	Setting wheel lever complete			
808805	Date dial guard			
810720	Date jumper			
811720	Date jumper spring			
817805	Intermediate date wheel			
820805	Intermediate date driving wheel			
855805	Setting wheel rocker			

—continued on the next page—

☆ ⇨ Please see remarks on the reverse page.

Calibre No. 4006A		Jewels 27j	Style Name (Bell Matic)	
PART NO.	LIST OF MATERIALS	PART NO.	LIST OF MATERIALS	
	—continued—			
01111	Upper hole jewel for barrel			
011145	Upper hole jewel for center wheel			
011145	Lower hole jewel for center wheel			
011307	Upper hole jewel for 3rd wheel			
011405	Lower hole jewel for 3rd wheel			
011307	Upper hole jewel for sweep second wheel			
011312	Upper hole jewel for escape wheel			
011406	Lower hole jewel for escape wheel			
011503	Upper hole jewel for pallet			
011503	Lower hole jewel for pallet			
011112	Upper hole jewel for transmission wheel			
011112	Lower hole jewel for transmission wheel			
011115	Upper hole jewel for alarm barrel arbor			
023150	Tube for pallet cock screw			
023151	Tube for bridge screw (Cylinder type)			
023151	Tube for center wheel bridge screw			
023151	Tube for alarm setting lever screw			
023155	Tube for setting lever spring screw			
023155	Tube for calendar plate screw			
023168	Tube for alarm intermediate wheel rocker screw			
023169	Tube for alarm bolt yoke screw			
023177	Tube for bridge screw (Recessed type)			
	Pusher for unlocking button			
	Casing spring			
8133006	Alarm setting wheel			
☆8608998	Button axle			
8999984				
Remarks :				
Date dial				
☆801805.....Used when both the crown and the date frame are located at 3 o'clock				
If the date dial of this calibre is required in any other type, specify (1) Cal. No. (2) the crown position and (3) the date frame position				
Day star with dial disk				
☆870805.....Used when both the crown and the day frame are located at 3 o'clock				
If the day star with dial disk is required in any other type, specify the number printed on the disk.				
Alarm setting wheel				
☆8608998.....When you order alarm setting wheel, specify the dial number.				

☆ ⇨ Please see remarks.

Items in light letters are not shown in photos.

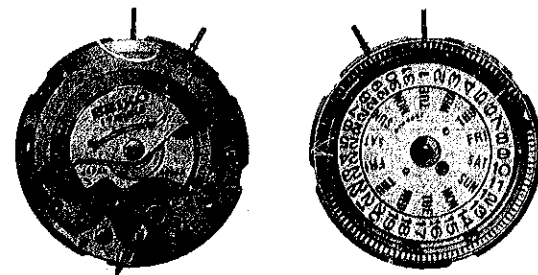

Cal. 4006A

Characteristics

Casing diameter: 31.20 ϕ mm
 Maximum height: 7.15 mm
 Vibrations per hour: 19,800
 Automatic winding with sweep second
 Calendar (day & date)
 Instant date setting
 Alarm device
 "Diashock" Shock Resistant Device

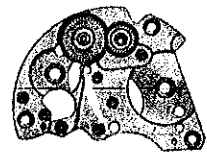

112806



500808

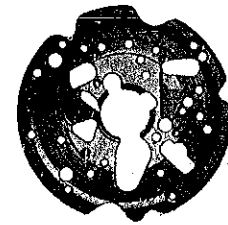

195806

As for all other parts not shown here, please refer to the basic calibre
 (Cal. No. 4006A 27J Catalog No. 40-06-1 Green page).

Calibre No. 4006A		Jewels 17j	Style Name (Bell Matic)	
⇒ Basic Calibre 4006A 27J Catalog No. 40-06-1				
PART NO.	LIST OF MATERIALS	PART NO.	LIST OF MATERIALS	
112806	Barrel & train-wheel bridge	875400	Setting wheel lever spring	
122805	Center wheel bridge	880805	Date corrector	
161805	Pallet cock	883805	Date corrector spring	
171805	Balance cock	218805	Alarm barrel arbor	
191805	Framework for automatic device	254805	Alarm wheel	
195806	Calendar plate	290805	Alarm ratchet wheel	
205805	Complete barrel with arbor	416805	Alarm mainspring (self-greasing)	
213805	Barrel arbor	419805	Alarm mainspring seat	
224805	Center wheel & pinion with cannon pinion	934805	Intermediate wheel rocker for alarm	
225805	Cannon pinion	936805	Alarm hammer	
231660	Third wheel & pinion	941805	Sounding spring	
241805	Sweep second wheel & pinion	942805	Alarm bolt yoke	
251805	Escape wheel & pinion	943805	Alarm setting lever	
261805	Minute wheel	944805	Alarm bolt yoke spring	
271805	Hour wheel	945805	Disconnecting lever	
281805	Setting wheel	946805	Disconnecting lever spring	
282805	Clutch wheel	947805	Alarm setting lever spring	
283805	Winding pinion	948805	Unlocking wheel	
285690	Ratchet wheel	949805	Friction spring for unlocking wheel	
301660	Jewelled pallet fork & staff	950805	Intermediate unlocking wheel	
310470	Balance complete with stud	952805	Alarm setting wheel holder	
315470	Balance staff	954805	Intermediate alarm setting wheel	
331610	Roller with jewel	022150	Stud screw	
341805	Regulator	022250	Holder screw for transmission wheel & pawl lever	
345470	Stud holder		Click screw	
354805	Winding stem	022251	Click screw	
381610	Click	022254	Disconnecting lever spring screw	
383805	Setting lever	022256	Pallet cock screw	
384805	Yoke (Clutch lever)	022257	Center wheel bridge screw	
385610	Yoke spring (Clutch lever spring)	022257	Setting lever spring screw (Cheese-head screw)	
388805	Setting lever spring		Date corrector spring screw	
390805	Setting lever axle	022257	Calendar plate screw	
401805	Mainspring with slipping attachment	022257	Alarm setting lever spring screw	
480805	Setting wheel ring	022266	Alarm setting wheel holder screw	
491400	Dial washer	022268	Framework screw for automatic device	
957805	Intermediate minute wheel	022365	Sounding spring screw	
014223	Diashock upper frame	022450	Bridge screw	
014244	Diashock lower frame	022455	Dial screw	
014285	Diashock hole jewel with frame	022458	Screw for oscillating weight	
011205	Diashock upper cap jewel	022462	Ratchet wheel screw	
011210	Diashock lower cap jewel	022464	Alarm bolt yoke screw	
014217	Diashock spring	022466	Intermediate wheel rocker screw for alarm	
500808	Oscillating weight	022474	Date dial guard screw	
505690	Transmission wheel	022573	Screw for day & date driving wheel	
821690	Ball-bearing for oscillating weight	022574	Setting wheel lever screw	
831610	Pawl lever with jewel	022575	Alarm ratchet wheel screw	
835610	Ball-bearing holder	022662	Setting lever spring screw (Step screw)	
838690	Pawl lever seat	022776	Ball-bearing holder screw	
839805	Holder for transmission wheel & pawl lever	011145	Upper hole jewel for center wheel	
550805	Date finger washer	011145	Lower hole jewel for center wheel	
550805	Setting wheel rocker washer	011405	Lower hole jewel for 3rd wheel	
556805	Date finger	011312	Upper hole jewel for escape wheel	
☆ 801805	Date dial	011406	Lower hole jewel for escape wheel	
803805	Setting wheel lever complete	011503	Upper hole jewel for pallet	
808805	Date dial guard	011503	Lower hole jewel for pallet	
810720	Date jumper	011112	Upper hole jewel for transmission wheel	
811720	Date jumper spring	011112	Lower hole jewel for transmission wheel	
817805	Intermediate date wheel			
820805	Intermediate date driving wheel			
855805	Setting wheel rocker			
867805	Day & date driving wheel			
☆ 870805	Day star with dial disk			

— continued on the next page —

☆ ⇒ Please see remarks on the next page.

Items in light letters are not shown in photos; those parts are interchangeable with the basic calibre

(Cal. No. 4006A 27J Catalog No. 40-06-1 Green page).

Calibre No.	4006A	Jewels	17j	Style Name	(Bell Matic)
⇒ Basic Calibre 4006A 27J Catalog No. 40-06-1					

PART NO.	LIST OF MATERIALS	PART NO.	LIST OF MATERIALS
023150	Tube for pallet cock screw		
023151	Tube for center wheel bridge screw		
023151	Tube for alarm setting lever screw		
023155	Tube for setting lever spring screw		
023155	Tube for calendar plate screw		
023168	Tube for alarm intermediate wheel rocker screw		
023169	Tube for alarm bolt yoke screw		
023177	Tube for barrel & train-wheel bridge screw		
023968	Pusher for unlocking button		
8133006	Casing spring		
☆ 8608991	Alarm setting wheel		
8999984	Button axle		

Remarks:

Date dial

☆801805.....Used when both the crown and the date frame are located at **3** o'clock.
 If the date dial of this calibre is required in any other type, specify ① Cal. No. ② the crown position
 ③ the date frame position and ④ the dial No.

Day star with dial disk

☆870805.....Used when both the crown and the day frame are located at **3** o'clock.
 If the day star with dial disk is required in any other type, specify the number printed on the disk.

Alarm setting wheel

☆8608991.....When you order alarm setting wheel, specify the dial number.

☆⇒ Please see remarks.

Items in light letters are not shown in photos; those parts are interchangeable with the basic calibre
 (Cal. No. **4006A** 27J Catalog No. 40-06-1 Green page).

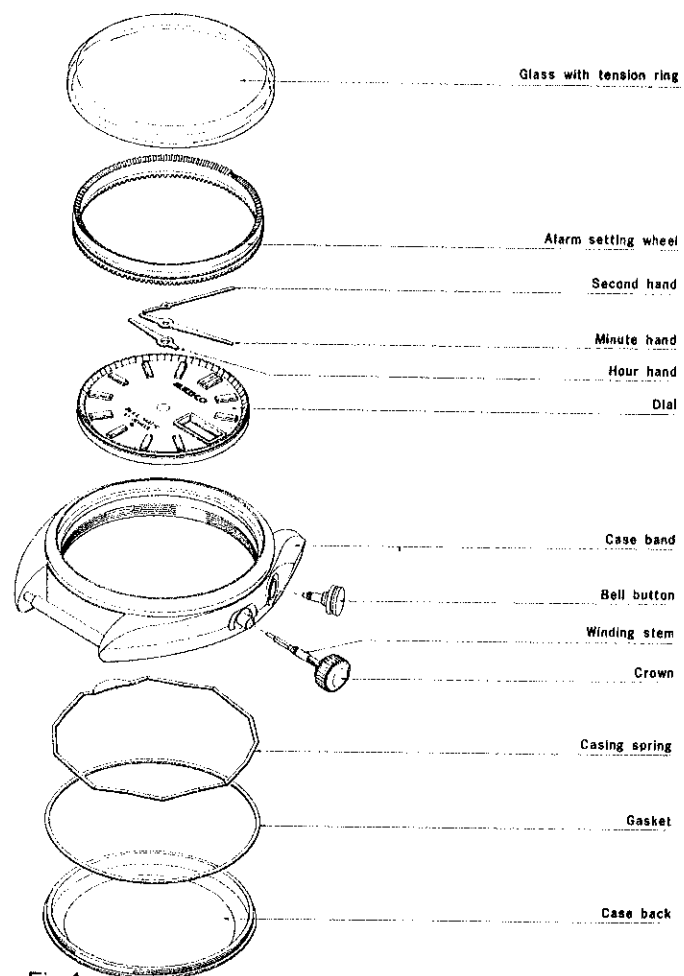

Fig. 1

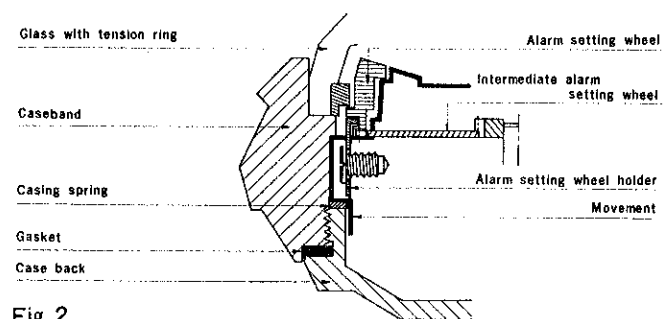

Fig. 2

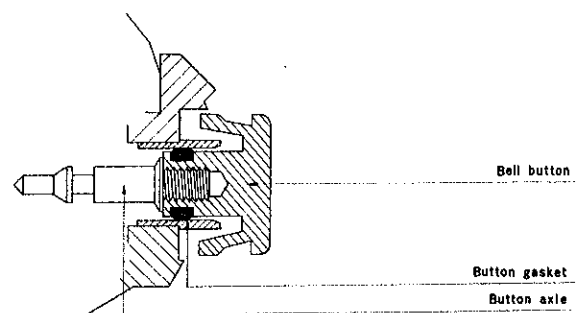

Fig. 3

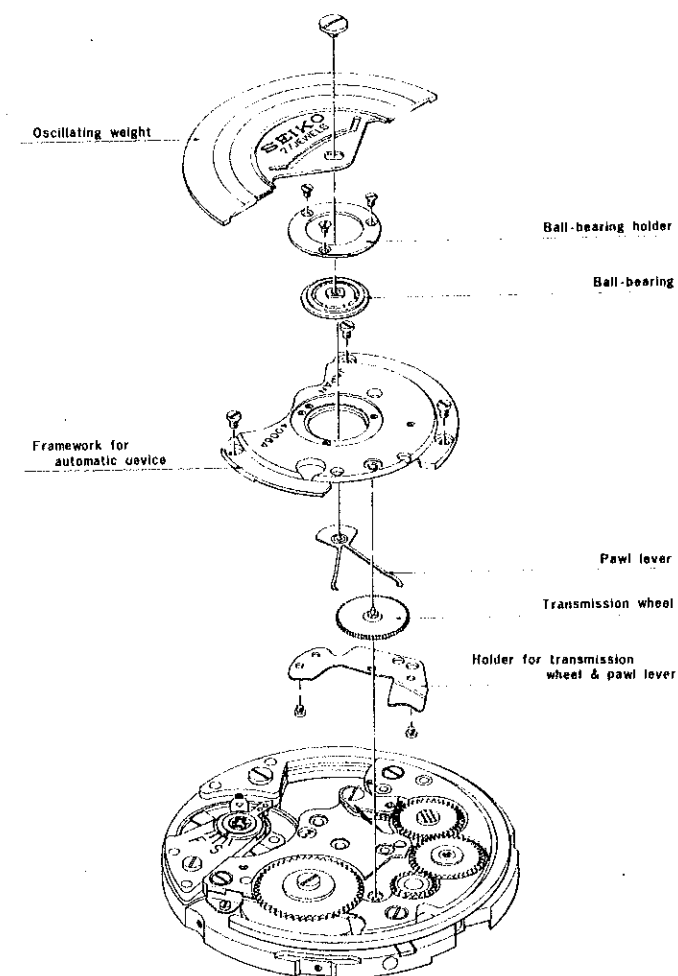

Fig. 4

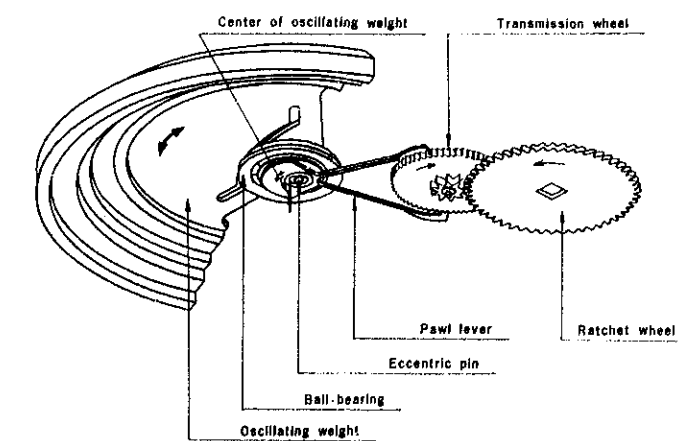

Fig. 5

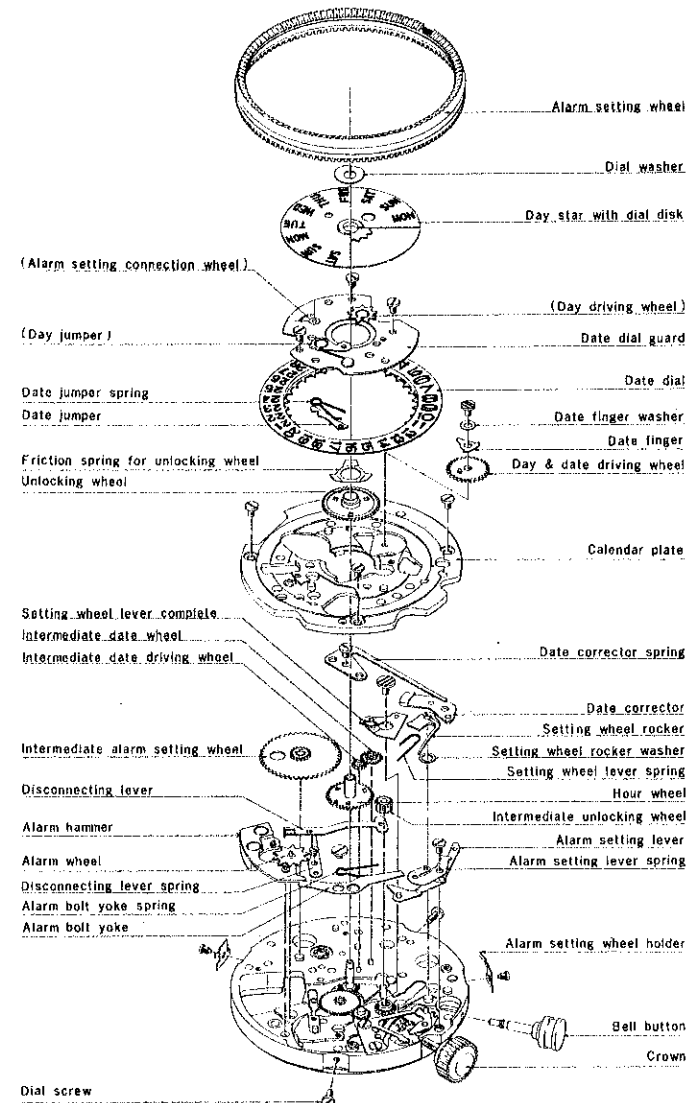

Fig. 6

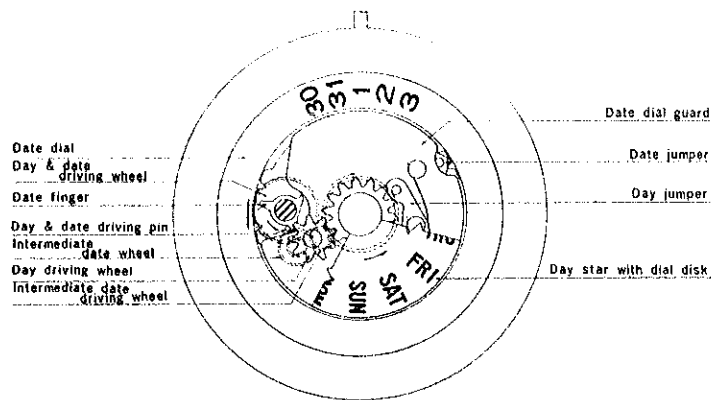

Fig. 7

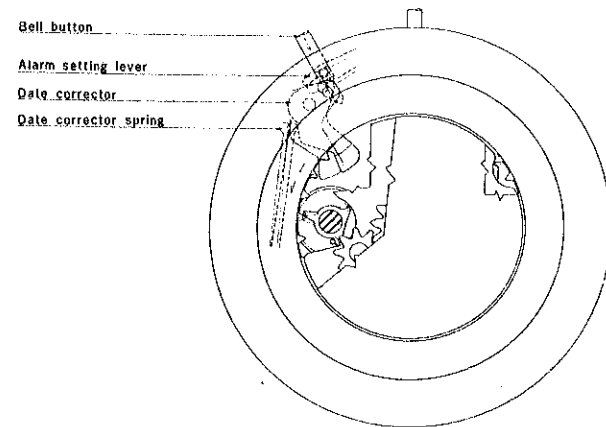

Fig. 8

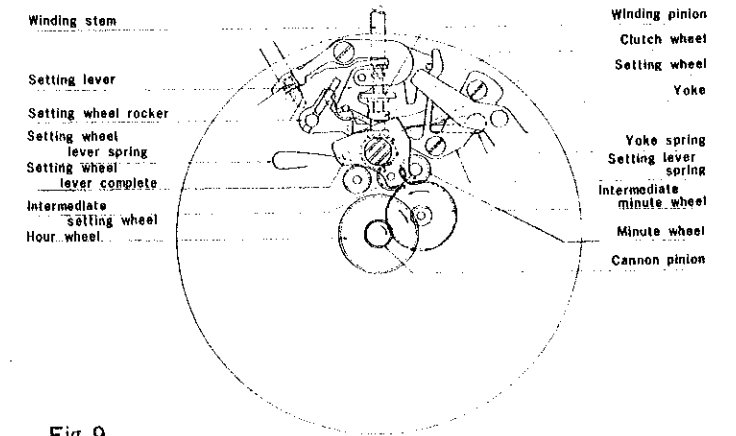

Fig. 9

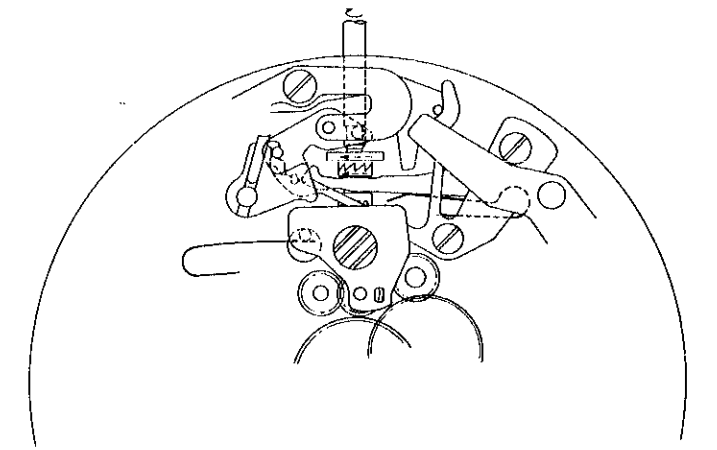

Fig. 10

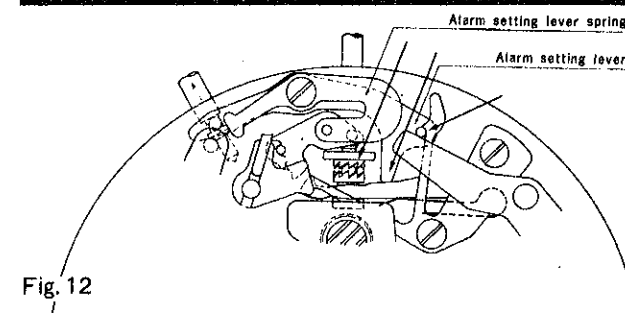

Fig. 12

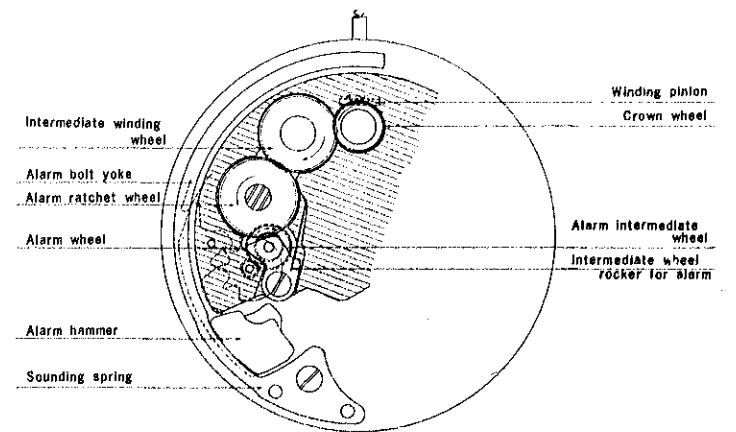

Fig. 11

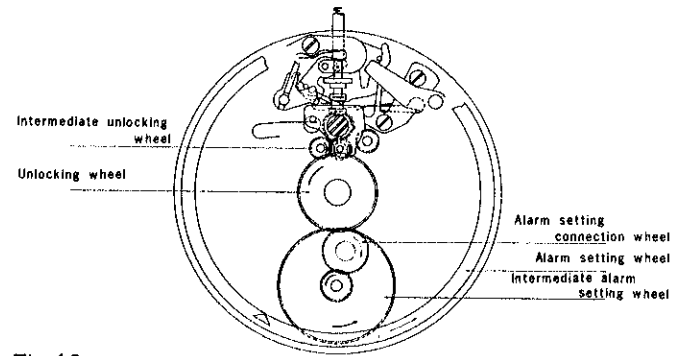

Fig. 13

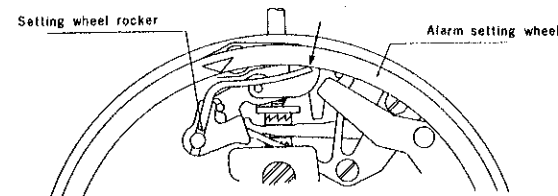

Fig. 14

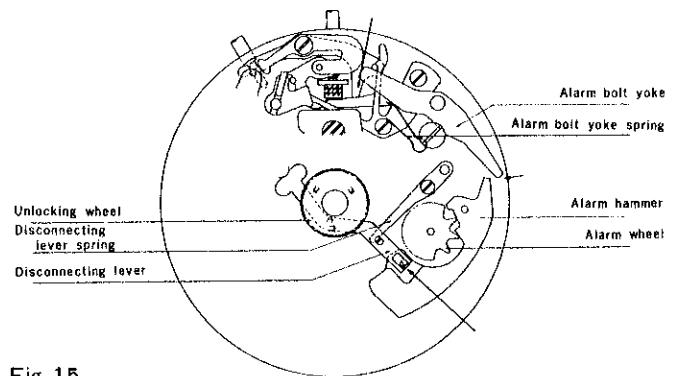

Fig. 15

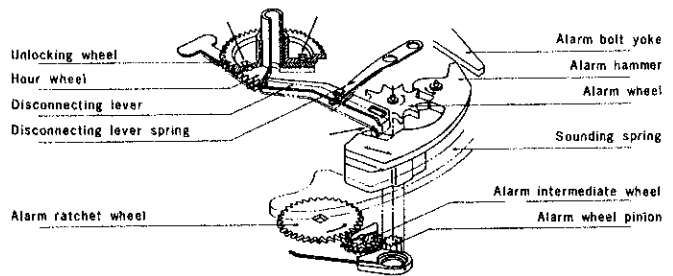

Fig. 16

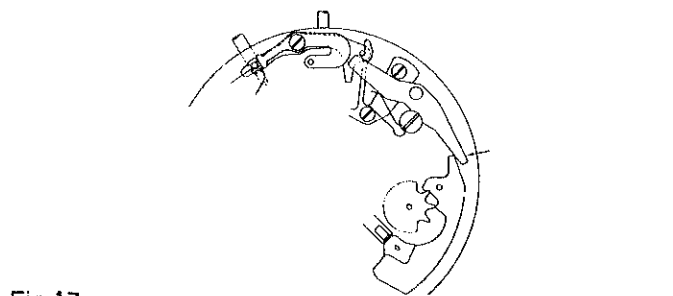

Fig. 17

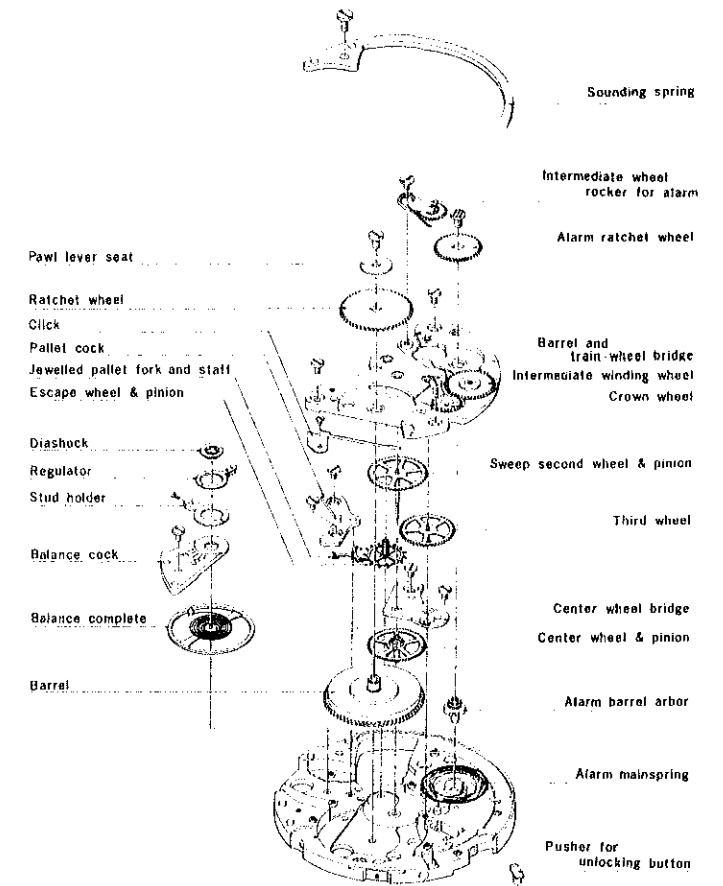

Fig. 18

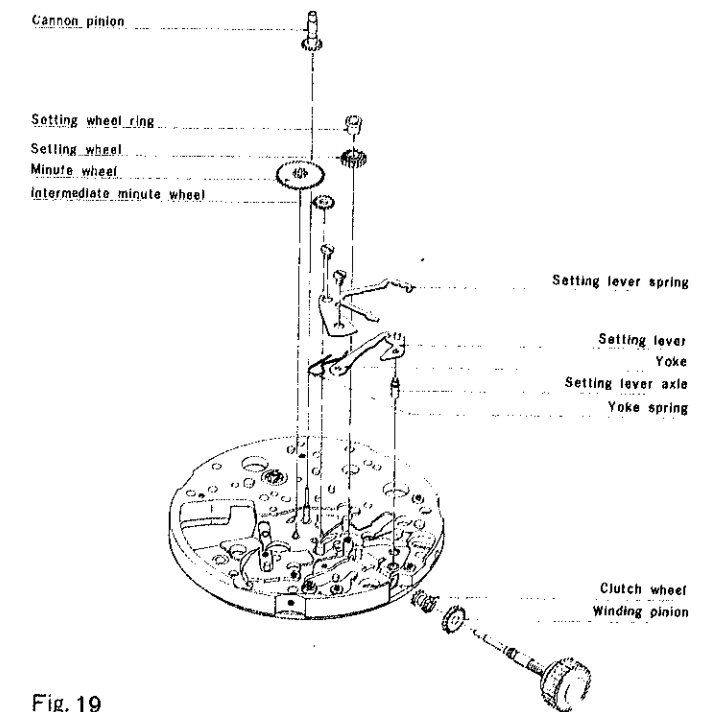
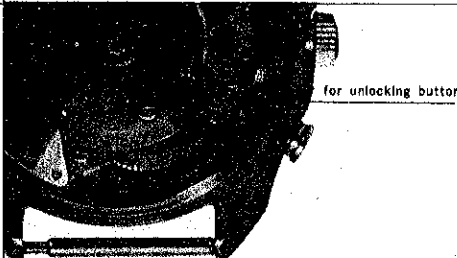

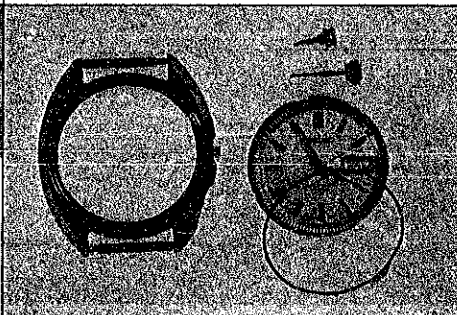

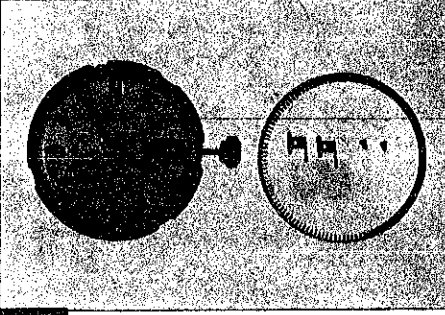
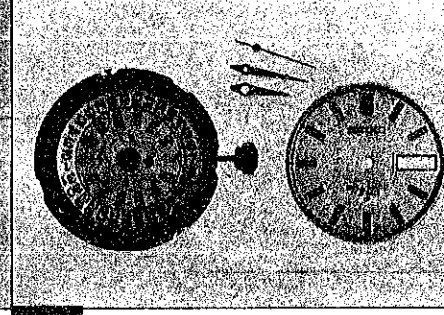
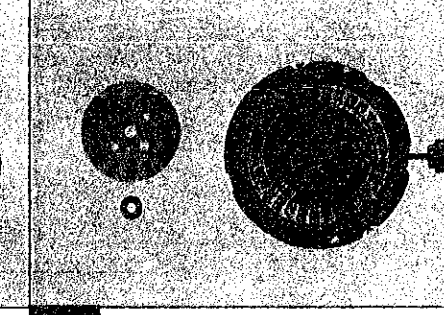

Fig. 19

4006A Disassembly and assembly—continued



4006A Disassembly and assembly—continued



Disassembly	1 CASE BACK	2 REMOVAL OF MOVEMENT	
	<ol style="list-style-type: none"> 1) Set case in case-holder held by vise 2) Remove case back with SEIKO case opener 3) Remove case back gasket <p>Concerning use of case-holder and opener, refer to item entitled Instruments for Repairing and Testing Machines.</p>	<ol style="list-style-type: none"> 1) Remove case spring 2) Remove bell button by pushing pusher for unlocking button 3) Remove winding stem by pushing setting lever axle 4) Turn case upside down and gently remove movement from case. Be careful not to deform case spring 	
Remark	Usually there is no need of removing glass; however, when it is necessary to do so, remove glass by pushing it from inside. (It is not necessary to remove bezel.)		
Photo			
Assembly	32 CHECKING	31 CASE BACK	30 CASING
	<ol style="list-style-type: none"> 1) Space between hands 2) The position of crown 3) Rotation of hands 4) Positions of hour and minute hands at 12 o'clock 5) Date changes near midnight; day changes near 1 A.M. 6) Date setting 7) Bell time setting 8) Stopping the bell 9) Waterproof test 	<ol style="list-style-type: none"> 1) Thinly apply silicon grease (500,000 c. s.) to case back gasket 2) Mount case back gasket on case back 3) Assemble case back with case-holder and opener. Tighten case back securely and completely. 	<ol style="list-style-type: none"> 1) Remove winding stem and bell button 2) Insert movement in case 3) Apply silicon grease (500,000 c.s.) to crown gasket 4) Set winding stem 5) Apply silicon grease (500,000 c.s.) to bell button gasket 6) Set bell button 7) Align projection of casing spring with dented portion on the case (near balance wheel) and set casing spring (Refer to drawing to avoid confusing front and back)
Remark			

Disassembly	3 ALARM SETTING WHEEL	4 DIAL	5 DAY STAR WITH DIAL DISK
	<ol style="list-style-type: none"> 1) Set winding stem to facilitate disassembling. (It can be set by merely inserting winding stem without pushing setting lever axle) 2) Remove alarm setting wheel holder screws (2 pcs.) 3) Remove alarm setting wheel holders 4) After pulling crown to second or third position, remove alarm setting wheel 	<ol style="list-style-type: none"> 1) Remove second hand, minute hand, and hour hand 2) Loosen dial screws and remove dial 	<ol style="list-style-type: none"> 1) Remove dial washer and day star with dial disk
Remark	Setting wheel rocker spring is designed to project from periphery of plate; consequently, disassemble or reassemble watch very carefully. When crown is pulled to second or third position, spring withdraws.		
Photo			
Assembly	29 ALARM SETTING WHEEL	28 DIAL	27 DAY STAR WITH DIAL DISK
	<ol style="list-style-type: none"> 1) Pull crown to third position and turn it, then set hands to 12 o'clock 2) Turn crown at second position, stopping crown at moment bell begins to ring. Then set alarm setting wheel in such a position that its set-mark is aligned with 12 o'clock 3) Set alarm setting wheel holders and screws while holding alarm setting wheel and intermediate alarm setting wheel in an engaged condition 4) Check bell ringing time and reset alarm setting wheel if too large an error of bell ringing time exists (Normal tolerance : ± 5 minutes) 	<ol style="list-style-type: none"> 1) Set dial and tighten dial screws 2) Turn crown at third position, stop crown on moment when date dial is changed, and set hour hand and minute hand to 12 o'clock 3) When projection of hour wheel enters hole of unlocking wheel (bell ringing time), check clearance between hour hand and dial. (As hands advance, one position is reached where hour hand is elevated to a higher position. Reverse hands therefrom and check hour hand and minute hand by setting one over the other) 4) Set second hand 	<ol style="list-style-type: none"> 1) Correct day jumper position 2) Set day star with dial disk (Mesh day star with day jumper head through hole of dial disk) 3) Set dial washer
Remark			Proper height of dial washer is 0.25mm, equal to thickness of setting lever spring.

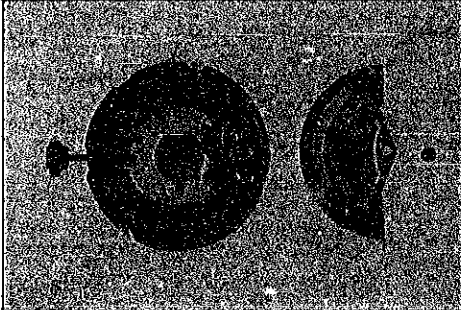
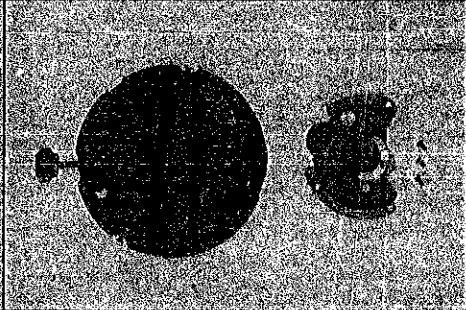
4006A Disassembly and assembly—continued

4006A Disassembly and assembly—continued

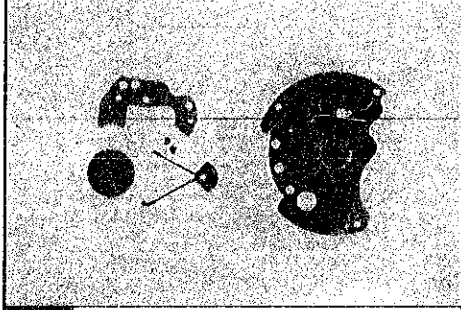
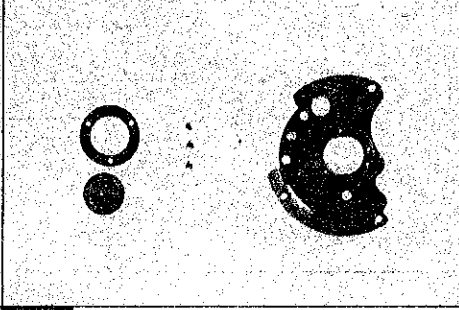
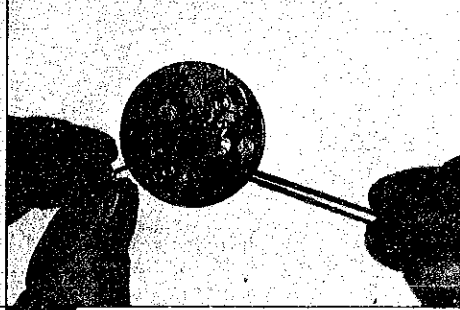
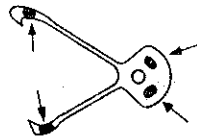
Disassembly	6	OSCILLATING WEIGHT	7	FRAMEWORK FOR AUTOMATIC DEVICE
	<ol style="list-style-type: none"> 1) Remove screw for oscillating weight 2) Remove oscillating weight 		<ol style="list-style-type: none"> 1) Remove framework screws for automatic device (3 pcs.) 2) Remove framework for automatic device 	
Photo				
Assembly	26	INSPECTION	25	OSCILLATING WEIGHT
	<ol style="list-style-type: none"> 1) Make sure that pawl lever is correctly engaged with transmission wheel 2) Check automatic winding operating conditions 3) Inspect overall movement 		<ol style="list-style-type: none"> 1) Set oscillating weight and screw for oscillating weight 	
Photo				
Remark			<p>Tighten screw for oscillating weight securely. Check contacting conditions with sounding spring.</p>	

Disassembly	8	TRANSMISSION WHEEL	9	BALL-BEARING	10	ALARM MAINSPRING
	<ol style="list-style-type: none"> 1) Remove holder screws for transmission wheel and pawl lever (2 pcs.) 2) Remove holder for transmission wheel and pawl lever 3) Remove transmission wheel and pawl lever 		<ol style="list-style-type: none"> 1) Remove ball-bearing holder screws (3 pcs.) 2) Remove ball-bearing holder. 3) Remove ball-bearing. 		<ol style="list-style-type: none"> 1) Disengage alarm intermediate wheel and alarm wheel pinion with a pair of tweezers (by turning intermediate wheel rocker for alarm clockwise); then unwind alarm mainspring slowly by operating crown (see photo) or by ringing bell 	
Photo						
Remark	<p>Be careful not to deform pawl lever.</p>		<p>Ball-bearing cannot be disassembled.</p>			
Assembly	23	TRANSMISSION WHEEL	22	BALL-BEARING	21	CHECK ON BELL RINGING CONDITION
	<ol style="list-style-type: none"> 1) Lubricate pawl lever (watch oil S-4 or Moebius grease "Remontoires") 2) Set transmission wheel 3) Set pawl lever and mesh it with transmission wheel 4) Set holder for transmission wheel and pawl lever, and holder screws for transmission wheel and pawl lever 		<ol style="list-style-type: none"> 1) Set ball-bearing, ball-bearing holder, and ball-bearing holder screws 2) Lubricate each ball in ball-bearing with Moebius Synt-A-Lube 3) Lubricate eccentric pin (watch oil S-4); See remarks below 		<ol style="list-style-type: none"> 1) Wind alarm mainspring and pull out bell button. Turn crown at second position, making sure that bell rings when projections of hour wheel fit in holes of unlocking wheel 2) Check date correction and date driving conditions 	
Photo						
Remark						

Disassembly	11	DATE DIAL	<ol style="list-style-type: none"> 1) Remove date dial guard screws (3 pcs.) 2) Remove date dial guard 3) Remove date jumper spring and date jumper 4) Remove date dial
	12	HOUR WHEEL	<ol style="list-style-type: none"> 1) Remove friction spring for unlocking wheel 2) Remove unlocking wheel 3) Remove hour wheel
	13	DAY & DATE DRIVING WHEEL	<ol style="list-style-type: none"> 1) Remove screw for day and date driving wheel 2) Remove date finger washer, date finger, and day & date driving wheel
Remark			Because it has left-handed threads, loosen screw for day & date driving wheel by turning it to the right.
Photo			
Assembly	20	DATE DIAL	<ol style="list-style-type: none"> 1) Lubricate date dial contacting part of calendar plate (Moebius Synt-A-Lube) 2) Lubricate alarm setting connection wheel on back side of date dial guard (Moebius Synt-A-Lube) 3) Set date dial 4) Lubricate engaging part between date jumper and date dial (Moebius Synt-A-Lube) 5) Set date jumper and date jumper spring 6) Set date dial guard and screws
	19	HOUR WHEEL	<ol style="list-style-type: none"> 1) Lubricate upper and lower pivot of alarm wheel and alarm hammer (watch oil S-4 or Moebius grease "Remontoires") 2) Lubricate cannon pinion (Moebius Synt-A-Lube) 3) Lubricate hour wheel (Moebius Synt-A-Lube) 4) Set hour wheel 5) Lubricate unlocking wheel with watch oil S-4 or Moebius grease "Remontoires" 6) Set unlocking wheel
	18	DAY & DATE DRIVING WHEEL	<ol style="list-style-type: none"> 1) Lubricate day & date driving wheel axle (Moebius Synt-A-Lube) 2) Set day & date driving wheel 3) Set date finger 4) Set date finger washer (open downward) 5) Set the screw for day and date driving wheel (tighten by turning to left)
Remark			Be sure to position date finger against day driving pin correctly (refer to photo of Hour Wheel)
Photo			

Disassembly	14	CALENDAR PLATE	<ol style="list-style-type: none"> 1) Remove calendar plate screws (3 pcs.) 2) Remove calendar plate
	15	INTERMEDIATE ALARM SETTING WHEEL	<ol style="list-style-type: none"> 1) Remove intermediate alarm setting wheel 2) Remove intermediate date wheel 3) Remove intermediate date driving wheel 4) Remove disconnecting lever 5) Remove disconnecting lever spring screw 6) Remove disconnecting lever spring 7) Remove minute wheel 8) Remove intermediate unlocking wheel
	16	DATE CORRECTOR LEVER	<ol style="list-style-type: none"> 1) Remove date corrector lever spring screw 2) Remove date corrector lever spring 3) Remove date corrector lever 4) Remove setting wheel rocker 5) Remove setting wheel rocker washer
Remark			Do not inadvertently remove the screw indicated by arrow in photo. It is date corrector spring screw. Intermediate date driving wheel and intermediate unlocking wheel are often removed together with calendar plate.
Photo			
Assembly	17	CALENDAR PLATE	<ol style="list-style-type: none"> 1) Set calendar plate and its screws 2) Check bell for ringing conditions Wind alarm mainspring with crown, ascertaining that bell rings when bell button is pulled out to second position. If bell does not ring, check disconnecting lever or alarm train
	16	INTERMEDIATE ALARM SETTING WHEEL	<ol style="list-style-type: none"> 1) Lubricate intermediate unlocking wheel axle and minute wheel axle (Moebius Synt-A-Lube) 2) Set intermediate unlocking wheel 3) Set minute wheel 4) Lubricate intermediate date driving wheel axle, intermediate date wheel axle, and alarm setting connection wheel axle (Moebius Synt-A-Lube) 5) Set intermediate date driving wheel, intermediate date wheel, and intermediate alarm setting wheel 6) Set disconnecting lever spring and its screw 7) Lubricate disconnecting lever (watch oil S-4) 8) Set disconnecting lever
	15	DATE CORRECTOR LEVER	<ol style="list-style-type: none"> 1) Lubricate setting wheel rocker axle (watch oil S-4) 2) Set setting wheel rocker washer and setting wheel rocker (set crown to first position) 3) Lubricate date corrector lever axle (watch oil S-4, Moebius grease "Remontoires" or Moebius Synt-A-Lube) 4) Set date corrector lever after lubricating it (watch oil S-4 and Moebius Synt-A-Lube)
Remark			
Photo			

4006A Disassembly and assembly—continued

4006A Disassembly and assembly—continued

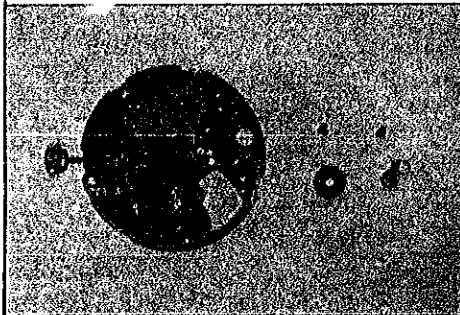
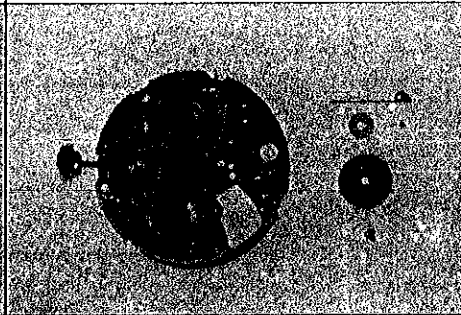
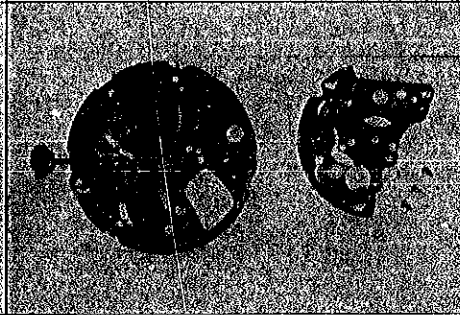
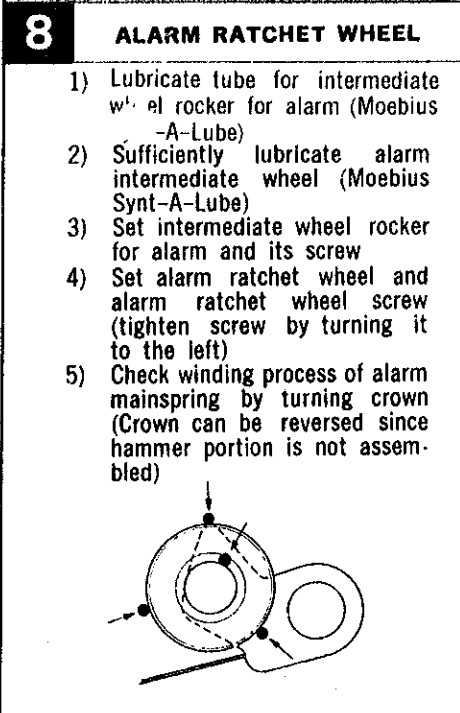
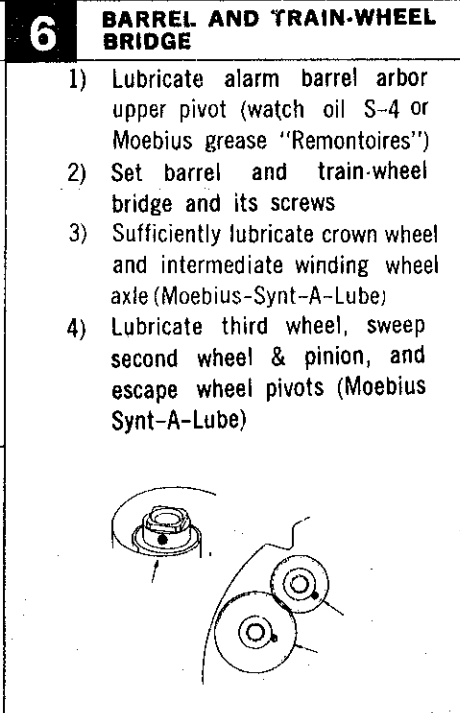

Disassembly	17	SETTING WHEEL LEVER COMPLETE	18	ALARM HAMMER	19	UNWINDING MAINSPRING
	<ol style="list-style-type: none"> 1) Remove setting wheel lever screw 2) Remove setting wheel lever complete 3) Remove setting wheel lever spring 4) Remove setting wheel ring and setting wheel 5) Remove intermediate minute wheel 		<ol style="list-style-type: none"> 1) Remove alarm wheel 2) Remove alarm hammer 3) Remove alarm bolt yoke spring 4) Remove alarm bolt yoke screw 5) Remove alarm bolt yoke 			
	<p>Because it has left-handed threads, loosen setting wheel lever screw by turning it to right.</p>				<p>When unwinding mainspring, let it unwind solely by its returning force.</p>	
Photo						
Assembly	14	SETTING WHEEL LEVER COMPLETE	13	ALARM HAMMER	12	AMPLITUDE INSPECTION
	<ol style="list-style-type: none"> 1) Lubricate setting wheel ring and intermediate minute wheel axle (Moebius Synt-A-Lube) 2) Set setting wheel and setting wheel ring 3) Set intermediate minute wheel 4) Lubricate setting wheel lever complete (Moebius Synt-A-Lube) 5) Set setting wheel lever complete 6) Set setting wheel lever screw (tighten by turning to left) 7) Ascertain that setting wheel lever complete moves to right and left smoothly 8) Set setting wheel lever spring 		<ol style="list-style-type: none"> 1) Lubricate alarm bolt yoke axle (watch oil S-4) 2) Lubricate alarm bolt yoke (watch oil S-4) 3) Set alarm bolt yoke 4) Set alarm bolt yoke screw (confirm mounting position by referring to 14) 5) Set alarm bolt yoke spring 6) Set alarm wheel 7) Lubricate alarm hammer (watch oil S-4 or Moebius grease "Remontoires") 8) Set alarm hammer 		<ol style="list-style-type: none"> 1) Check condition of hairspring 2) Wind spring fully. Hold movement vertical and check amplitude making sure that amplitude is 180° or larger (spring can be fully wound by turning ratchet wheel 8 or more times) 	

Disassembly	20	BALANCE COMPLETE	21	DIASHOCK	22	PALLET
	<ol style="list-style-type: none"> 1) Remove sounding spring screw 2) Remove sounding spring 3) Remove balance cock screw 4) Remove balance cock 5) Loosen stud screw and remove stud from stud holder 6) Remove balance by turning regulat key 		<ol style="list-style-type: none"> 1) Remove Diashock springs from plate and balance cock 2) Remove cap jewel and hole jewel with frame, cleaning them with benzine or trichlorethylene 		<ol style="list-style-type: none"> 1) Remove pallet cock screws (2 pcs.) 2) Remove pallet cock 3) Remove pallet 	
	<p>Pay attention to any deformation of sounding spring.</p>		<p>Wash with fresh cleaning solution using a brush.</p>			
Photo						
Assembly	11	BALANCE COMPLETE	10	DIASHOCK	9	PALLET
	<ol style="list-style-type: none"> 1) Set balance on balance cock 2) Place hairspring on regulator key and turn key 3) Tighten stud to stud holder with a screw. Flush upper surfaces of stud head and stud holder 4) Set balance cock and its screw 5) Set sounding spring and its screw 		<ol style="list-style-type: none"> 1) Place cap jewel with flat surface upward 2) Put drop of oil on its center, holding cap jewel with tweezers. Extent of lubrication: Dia. of hole jewels: Max. 1/2 Min. 1/3 3) Set Diashock frame with hole jewel directly over oiled cap jewel 		<ol style="list-style-type: none"> 1) Lubricate pallet jewels with Moebius Synt-A-Lube 2) Set pallet 3) Set pallet cock and screws 4) Check end shake of pallet 	
	<p>Check sounding spring and plate for contacting condition. (If sounding spring contacts something, a proper sound will not result.)</p>		<p>Lubricating Diashock: For assembling it in plate, refer to item on Diashock.</p>			

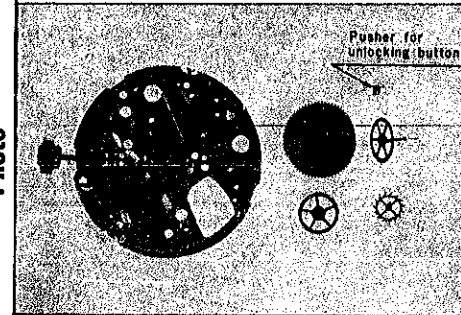
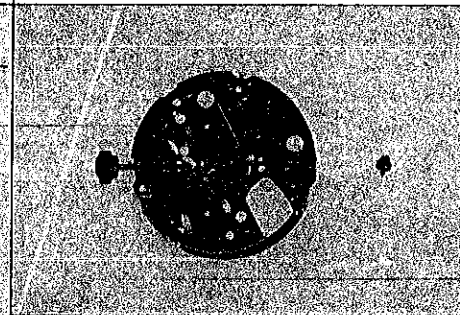
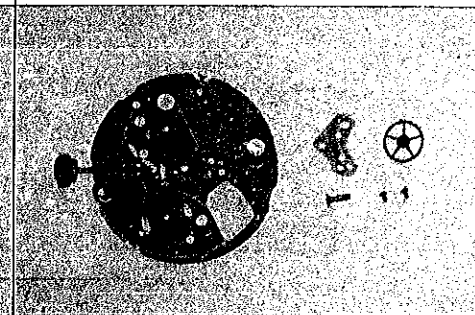
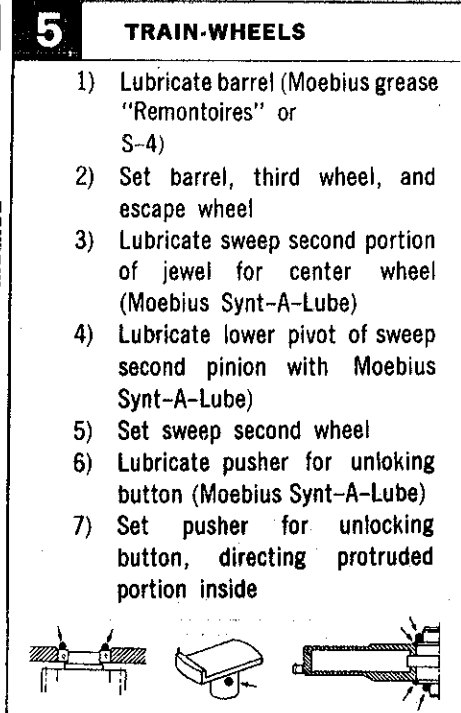
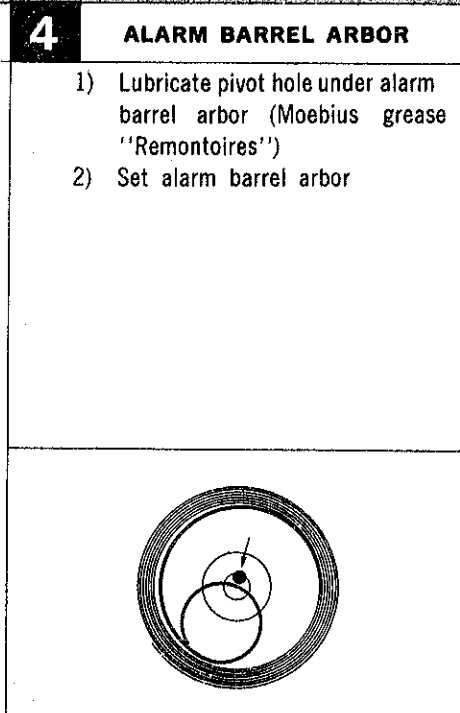
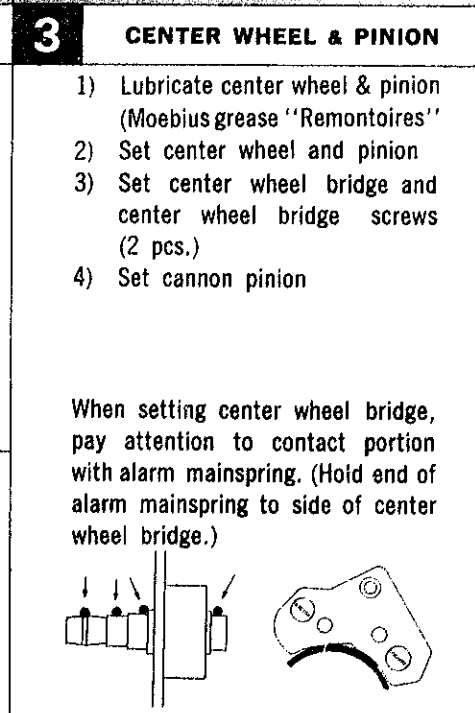
Method	23 ALARM RATCHET WHEEL	24 RATCHET WHEEL	25 BARREL AND TRAIN-WHEEL BRIDGE
	<ol style="list-style-type: none"> 1) Remove alarm ratchet wheel screw 2) Remove alarm ratchet wheel 3) Remove intermediate wheel rocker screw for alarm 4) Remove intermediate wheel rocker for alarm 	<ol style="list-style-type: none"> 1) Remove ratchet screw 2) Remove pawl lever seat and ratchet wheel 3) Remove click screw 4) Remove click 	<ol style="list-style-type: none"> 1) Remove bridge screws (3 pcs.) 2) Remove barrel and train wheel bridge
	<p>Because it has left-handed threads, loosen alarm ratchet wheel screw by turning it to the right. Pay attention to any deformation of spring of intermediate wheel rocker for alarm.</p>		<p>Do not disassemble crown wheel and intermediate winding wheel from the bridge. Remove barrel and train wheel bridge while holding alarm barrel arbor so that alarm mainspring does not project.</p>
Photo			
Method	8 ALARM RATCHET WHEEL	7 RATCHET WHEEL	6 BARREL AND TRAIN-WHEEL BRIDGE
	<ol style="list-style-type: none"> 1) Lubricate tube for intermediate wheel rocker for alarm (Moebius Synt-A-Lube) 2) Sufficiently lubricate alarm intermediate wheel (Moebius Synt-A-Lube) 3) Set intermediate wheel rocker for alarm and its screw 4) Set alarm ratchet wheel and alarm ratchet wheel screw (tighten screw by turning it to the left) 5) Check winding process of alarm mainspring by turning crown (Crown can be reversed since hammer portion is not assembled) 	<ol style="list-style-type: none"> 1) Set click and click screw 2) Set ratchet wheel, pawl lever seat, and ratchet wheel screw 3) Check condition of train wheels 	<ol style="list-style-type: none"> 1) Lubricate alarm barrel arbor upper pivot (watch oil S-4 or Moebius grease "Remontoires") 2) Set barrel and train-wheel bridge and its screws 3) Sufficiently lubricate crown wheel and intermediate winding wheel axle (Moebius-Synt-A-Lube) 4) Lubricate third wheel, sweep second wheel & pinion, and escape wheel pivots (Moebius Synt-A-Lube)
			
Remark			

Method	26 TRAIN-WHEELS	27 ALARM BARREL ARBOR	28 CENTER WHEEL & PINION
	<ol style="list-style-type: none"> 1) Remove escape wheel, sweep second wheel & pinion, third wheel, and barrel 2) Remove pusher for unlocking button 	<ol style="list-style-type: none"> 1) Remove alarm barrel arbor while holding alarm mainspring so that it does not project 	<ol style="list-style-type: none"> 1) Remove cannon pinion 2) Remove center wheel bridge screws (2 pcs.) 3) Remove center wheel bridge 4) Remove center wheel & pinion
		<p>There is no need of removing alarm mainspring because it is self-greasing spring. (Spring assembled in plate does not project even when washed with ultrasonic cleaner.)</p>	
Photo			
Method	5 TRAIN-WHEELS	4 ALARM BARREL ARBOR	3 CENTER WHEEL & PINION
	<ol style="list-style-type: none"> 1) Lubricate barrel (Moebius grease "Remontoires" or S-4) 2) Set barrel, third wheel, and escape wheel 3) Lubricate sweep second portion of jewel for center wheel (Moebius Synt-A-Lube) 4) Lubricate lower pivot of sweep second pinion with Moebius Synt-A-Lube) 5) Set sweep second wheel 6) Lubricate pusher for unloking button (Moebius Synt-A-Lube) 7) Set pusher for unlocking button, directing protruded portion inside 	<ol style="list-style-type: none"> 1) Lubricate pivot hole under alarm barrel arbor (Moebius grease "Remontoires") 2) Set alarm barrel arbor 	<ol style="list-style-type: none"> 1) Lubricate center wheel & pinion (Moebius grease "Remontoires") 2) Set center wheel and pinion 3) Set center wheel bridge and center wheel bridge screws (2 pcs.) 4) Set cannon pinion
			<p>When setting center wheel bridge, pay attention to contact portion with alarm mainspring. (Hold end of alarm mainspring to side of center wheel bridge.)</p> 
Remark			

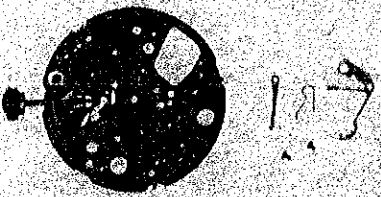
4006A Disassembly and assembly—continued

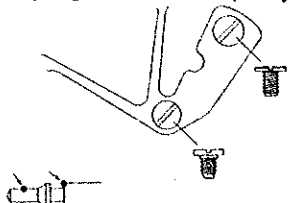
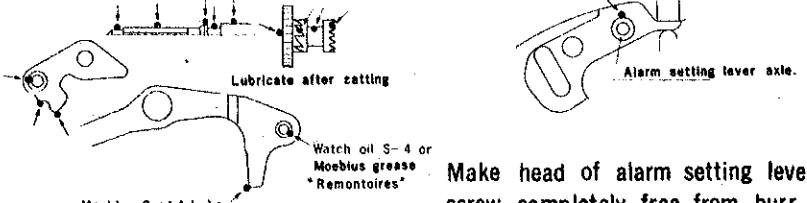
	29 YOKE	30 ALARM SETTING LEVER	31 CLEANING
Disassembly	<ol style="list-style-type: none"> 1) Remove setting lever spring screws (2 pcs.) 2) Remove setting lever spring 3) Remove yoke spring 4) Remove yoke 	<ol style="list-style-type: none"> 1) Remove alarm setting lever spring screw 2) Remove alarm setting lever spring 3) Remove alarm setting lever 4) Remove setting lever 5) Remove setting lever axle 6) Remove winding stem, clutch wheel, and winding pinion 	<p>Check and clean all parts so far disassembled. (For further particulars see the item on Cleaning.)</p>
Remark			
Photo			
Assembly	<ol style="list-style-type: none"> 1) Set yoke 2) Set yoke spring 3) Set setting lever spring and its screws 4) Lubricate the axle of the bell button (watch oil S-4 or Moebius grease "Remontoires") 5) Set bell button (Button can be set by merely depressing it) 	<ol style="list-style-type: none"> 1) Lubricate winding stem, winding pinion, and clutch wheel with Moebius Synt-A-Lube, then set them to plate 2) Set setting lever axle 3) Lubricate setting lever with watch oil S-4 or Moebius Synt-A-Lube 4) Lubricate alarm setting lever axle with watch oil S-4 or Moebius grease "Remontoires" 	<ol style="list-style-type: none"> 5) Lubricate alarm setting lever with watch oil S-4 and set it 6) Set alarm setting lever spring 7) Set alarm setting lever spring screw
Remark	<p>Generally, tighten screws completely</p> 	 <p>Make head of alarm setting lever screw completely free from burr.</p>	