

SEIKO

QUARTZ









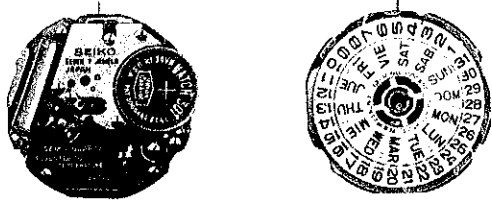

































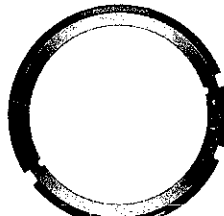
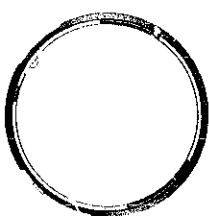
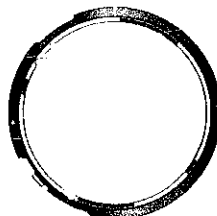



3003

(Cal. 4823A)

PARTS LIST

Calibre No. <h1 style="text-align: center;">4823A</h1>	Jewels <h1 style="text-align: center;">7j</h1>	Style Name <h1 style="text-align: center;">QUARTZ 3003</h1>
--	--	---

	<p>Characteristics :</p> <p>Casing diameter : 25.6 φmm Maximum height : 4.8 mm Frequency of quartz crystal oscillator : 32,768 Hz (Hz = Hertz Cycle per second)</p> <p>Driving system : Step motor system (6 poles) Regulation system : Trimmer condenser Rapid-second adjustment : Second hand stops to the next ten-second mark. Calendar (day & date) Instant setting device for day & date calendar Bilingual change-over system for day of week Battery life indicator : Second hand moves in two-second interval.</p>
---	---

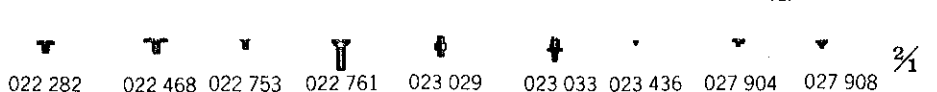
 122 680	 131 680	 221 680	 225 680	 231 680	 241 680	 261 611		
 271 680	 281 680	 282 680	 354 680	 383 680	 384 680	 386 680		
 389 680	 390 560	 391 680	 ☆397 680	 ☆397 681	 444 680	 480 680	 526 680	
 556 838	 760 680	 ☆801 550		 802 838	 808 680	 810 680	 817 610	 868 680
 ☆870 852	 873 680	 ☆884 955			 ☆884 957		 ☆884 958	
 963 838	 980 680	 981 680	 ☆4001 700		 4050 680	 4002 680		
 4146 680	 4216 836	 4219 680	 4239 680	 4242 681	 4455 680	 U.C.C. 301		
								

☆⇨ Please see remarks on the next reverse page.

Calibre No.		Jewels	Style Name	
4823A		7j	QUARTZ 3003	
PART NO.	PART NAME	PART NO.	PART NAME	
122 680	Center wheel bridge	022 468	Setting wheel ring screw	
131 680	Third wheel bridge	022 753	Day jumper screw	
221 680	Center wheel & pinion	022 753	Date dial guard screw	
225 680	Cannon pinion	022 761	Dial screw	
231 680	Third wheel & pinion	023 029	Tube for circuit block	
241 680	Fourth wheel & pinion	023 033	Tube for third wheel bridge screw	
261 611	Minute wheel	023 436	Reset lever pin	
271 680	Hour wheel	027 904	Second jumper adjusting pin	
281 680	Setting wheel	027 908	Second setting lever adjusting pin	
282 680	Clutch wheel	U.C.C.301	Silver oxide battery	
354 680	Winding stem			
383 680	Setting lever			
384 680	Yoke (Clutch lever)			
386 680	Setting lever spring			
389 680	Setting lever axle spring			
390 560	Setting lever axle			
391 680	Second-setting lever			
☆ 397 680	Lever for unlocking stem			
☆ 397 681				
444 680	Upper frame for hole jewel of fourth wheel			
460 680	Setting wheel ring			
526 680	Second-setting wheel			
556 838	Date finger			
760 680	Second jumper			
☆ 801 550	Date dial			
802 838	Date driving wheel			
808 680	Date dial guard A			
810 680	Date jumper			
817 610	Intermediate date wheel			
868 680	Day finger			
☆ 870 852	Day star with dial disk			
873 680	Day jumper			
☆ 884 955	Holding ring for dial			
☆ 884 957				
☆ 884 958				
963 838	Snap for day star with dial disk			
980 680	Intermediate wheel for day-date correction			
981 680	Day-date corrector wheel rocker			
4001 700	Circuit block			
4050 680	Circuit bridge			
4002 680	Coil block			
4146 680	Step rotor			
4216 836	Insulator A for battery connection			
4219 680	Insulator B for battery connection			
4239 680	Rotor stator			
4242 681	Plus terminal of battery connection			
4455 680	Reset lever			
011 406	Upper hole jewel for fourth wheel			
011 411	Upper cap jewel for step rotor			
011 411	Lower cap jewel for step rotor			
011 411	Upper hole jewel for third wheel			
011 411	Lower hole jewel for third wheel			
011 424	Upper hole jewel for second setting wheel			
022 282	Date driving wheel screw			
022 468	Center wheel bridge screw			
022 468	Third wheel bridge screw			
022 468	Circuit block screw			
022 468	Coil block screw			
022 468	Setting lever axle spring screw			
022 468	Setting lever spring screw			

☆⇨ Please see remarks on the reverse page.
Part numbers in light letters are not shown in photos.

Calibre No. 4823A	Jewels 7j	Style Name QUARTZ 3003
------------------------------------	----------------------------	---

Remarks :

Lever for unlocking stem

- ☆397 680.....Used for the one-piece type case with the dial whose external diameter is less than **27.5 mm** or used for the cases with dial shaped other than round.
- ☆397 681.....Used for the one-piece type case with the dial of **28.5 mm** external diameter.

Date dial

- ☆801 550.....Used when both the crown and the calendar frame are located at **3 o'clock** position.
If any other type of date dial is required, specify ① Cal. No. ② the crown position ③ the calendar frame position and ④ the dial No.

Day star with dial disk

- ☆870 852(English↔Spanish, black figures on the white background).....Used when both the crown and the calendar frame are located at **3 o'clock** position.
If any other type of day star with dial disk is required, specify the number printed on the disk.

Holding ring for dial

- ☆884 955.....Used only for the snap back case with the dial of **28.5 mm** external diameter.
- ☆884 957.....Used only for the one-piece type case with the dial of **27.5 mm** external diameter.
- ☆884 958.....Used only for the one-piece type case with the dial of **28.5 mm** external diameter.

The type of holding ring for dial is determined based on the design of cases and dials.
Check the case number and refer to "**SEIKO Quartz Casing Parts List**" to choose a corresponding holding ring for dial.

TECHNICAL GUIDE

SEIKO QUARTZ CAL.4823A

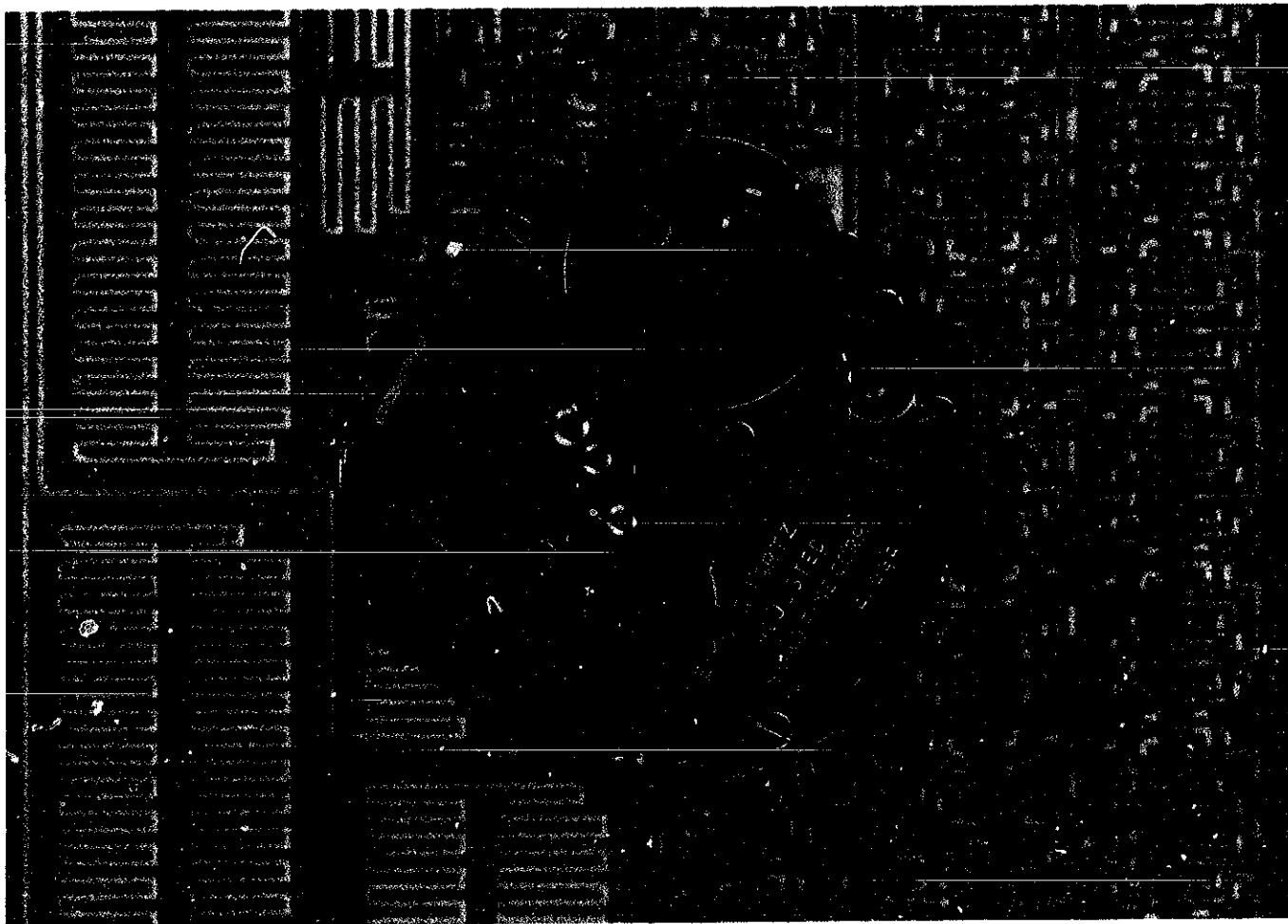

CONTENTS

I. Specifications and Features	2
1. Specifications	2
2. Features	2
II. Functioning	3
1. Movement structure	3
2. Outline of functioning	4
3. Functioning of electronic circuit block	4
4. Functioning of mechanical portion	6
III. How to set the time and calendar	8
1. Resetting time	8
2. Resetting calendar	8
IV. Case Construction	9
1. How to remove movement from one-piece type case	9
2. How to fix snap type case back	10
3. Battery replacement	10
V. After-sale Servicing Instruments and Materials	11
VI. Disassembling, Reassembling, Lubricating and Cleaning	12
1. Disassembling, Reassembling and Lubricating	12
(1) Calendar and setting mechanism	12
(2) Circuit block, coil block and movement mechanism	14
(3) Setting mechanism	16
2. Cleaning	17

SEIKO QUARTZ CRYSTAL WATCH Cal. 4823

The SEIKO QUARTZ CRYSTAL WATCH Cal. 4823 has been developed using similar technology as the other SEIKO Quartz Calibres, which has already gained a reputation for its high accuracy and reliability.

The calibre grade of this watch is similar to that of the Calibre 38 series. Moreover, this watch has adopted new advanced devices—Battery Life Indicator and Rapid Advance Second Setting Adjustment.

CHECKING AND ADJUSTMENT	18
1. Guide for checking and adjustment	18
2. Procedures for checking and adjustment	20
A: Check output signal	20
B: Check battery voltage	20
C: Check battery conductivity	20
D: Check reset switch	22
E: Check circuit block conductivity	22
F: Check circuit block output terminal conductivity	22
G: Check coil block	24
H: Check output signal	24
I: Check second setting lever	24
J: Check second jumper	26
K: Check second setting condition	26
L: Check reset condition	28
M: Check accuracy	30
Measuring current consumption	30

Calibre 4823A

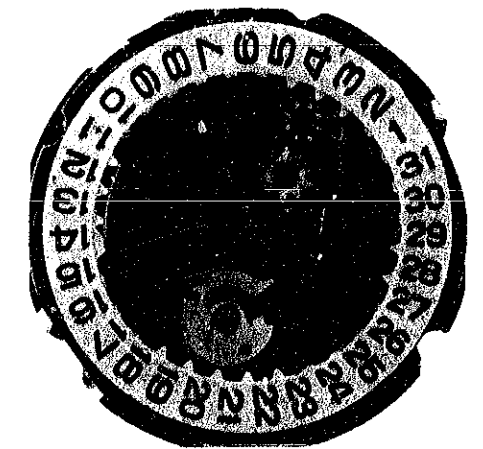

Movement

I. SPECIFICATIONS AND FEATURES

1. Specifications

Item	Cal. No.	4823A
Additional mechanism		Calendar (day & date) Bilingual change-over system for the day of the week Instant day and date setting Electronic circuit reset switch
Rapid advance second setting adjustment		Second hand stops to the next ten-second mark
Battery life indicator		Second hand moves in two-second intervals
Crystal oscillator		32,768 Hz (Hz = Hertz . . . Cycles per second)
Loss/gain		Loss/gain at normal temperature Monthly rate: less than 10 seconds (Annual rate: less than 2 minutes)
Casing diameter		φ 25.6 mm
Height		4.8 mm
Operational temperature range		-10°C ~ +60°C (14°F ~ 140°F)
Driving system		Step motor system (6 poles)
Regulation system		Trimmer condenser
Battery power		Battery life is over two years Silver oxide battery (U.C.C. 301) Voltage 1.5V
Jewels		7 jewels

2. Features

- (1) Cal. 4823A inherits the excellent reliability and durability of the SEIKO analogue type watches with quartz crystal oscillator already marketed.
 - (a) The quartz crystal oscillator because of its special shape generates a stabilized oscillation of 32,768 Hz.
 - (b) Second step system by step motor with stability and durability.
 - (c) Simplified block system facilitates easy after-sale servicing.
- (2) Rapid advance second setting system automatically moves the second hand to the next ten-second mark when the crown is pulled out. Therefore, time can be easily adjusted in accordance with the time signal of TV, radio and telephone.
- (3) Battery life indicator lets the second hand leap every 2 second when the battery life is coming to its end. This indicates the battery must be replaced. However, the watch keeps a correct time.
- (4) The movement is specially designed so that the battery will last for two years, although it uses an existing popular watch battery (U.C.C. 301).
- (5) A new bayonet type battery hatch facilitates easy replacement of battery.

II. FUNCTIONING

1. Movement structure

The movement consists of the circuit block, coil block, battery and the mechanical portion, of which the main component are a

step motor and a gear train. Since each portion is a separate unit, easy checking and adjustment is possible.

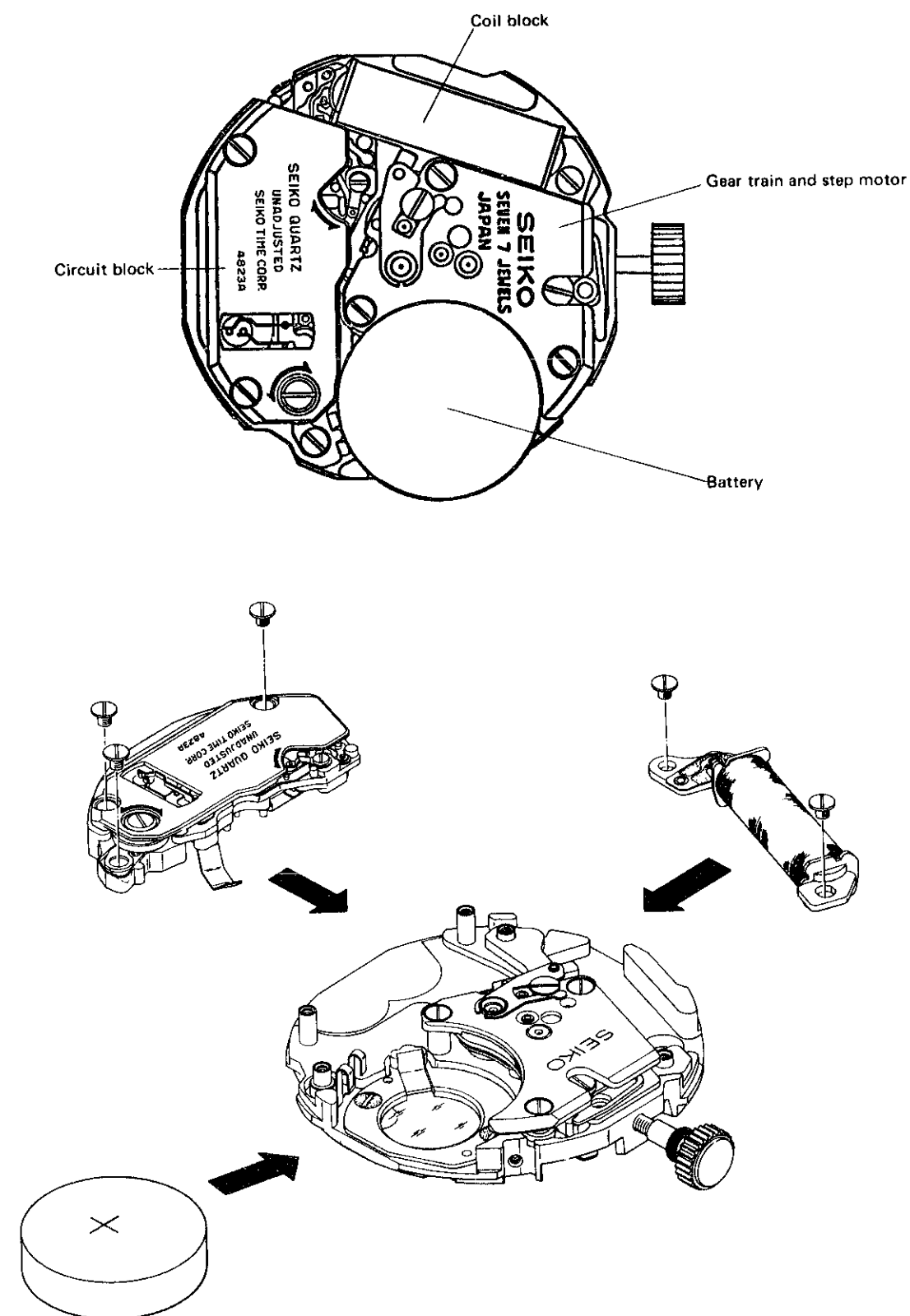

2. Outline of functioning

- (1) The quartz crystal oscillator, built in the crystal unit, oscillates accurately at 32,768 Hz.
- (2) The circuit unit receives the 32,768 Hz oscillations (electronic signals) and converts them into impulses at the rate of one per second, i.e. 1/2, 1/2, 1/2. . . .

- (3) The one-per-second signals are transmitted to the coil block, causing the step motor to momentarily rotate once every second in 60° increments.
- (4) This rotation is transmitted to the gear train thus moving the hands.

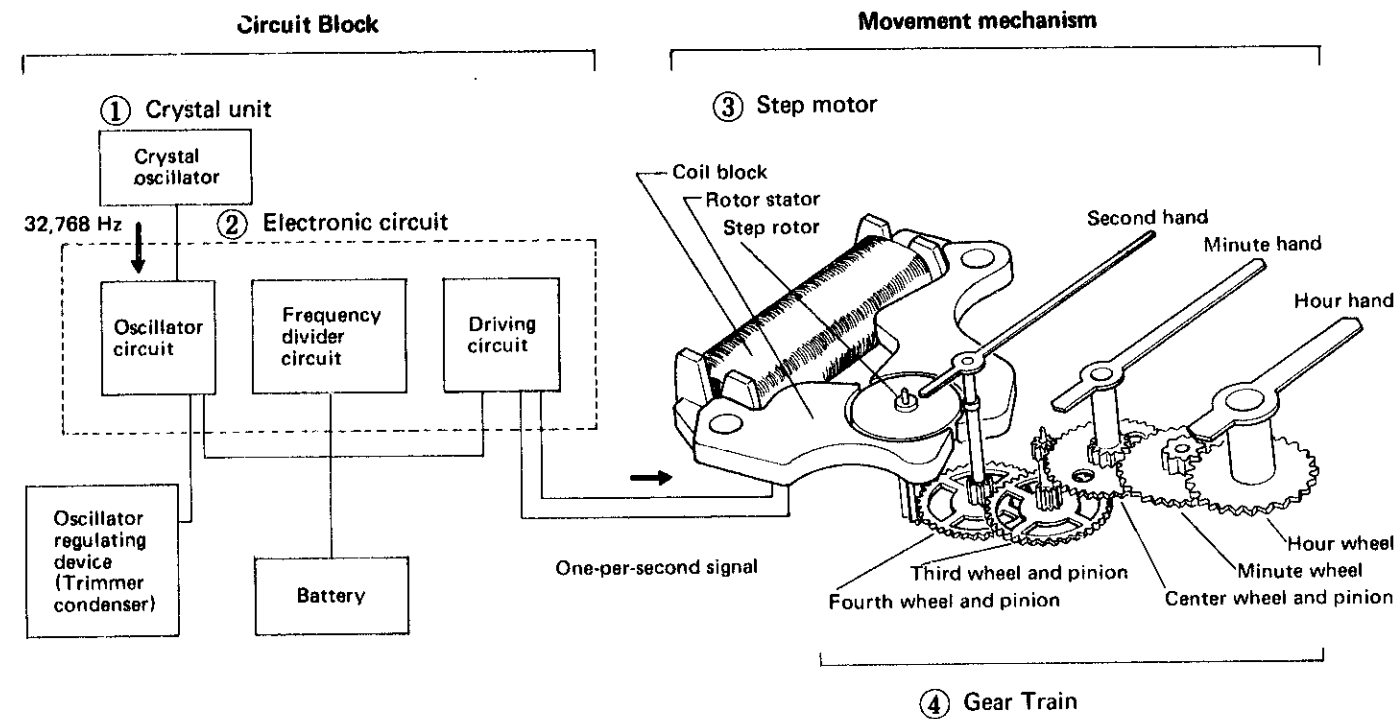

3. Functioning of electronic circuit block

(1) Circuit block

- The quartz crystal oscillator uses the SEIKO ultrasmall tuning fork shape and is housed in a flat-type vacuum capsule.

When voltage is supplied from the electronic circuit, the crystal oscillator makes stabilized oscillation exactly at 32,768 Hz which is the source of the high accuracy obtained in Cal. 4823A watch.

- A MOS IC of high reliability is used in the electronic circuit. The electronic circuit supplies voltage to the crystal oscillator to cause it to oscillate at 32,768 Hz and at the same time it takes out the oscillation in the form of an electrical signal. The oscillation of

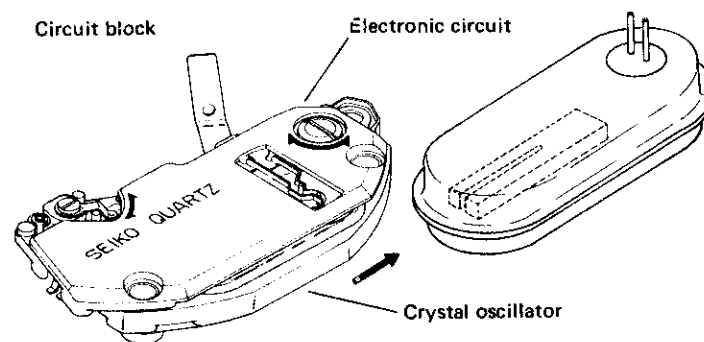

32,768 Hz is successively divided into 1/2 to finally obtain a signal per second, which is transmitted to the step motor.

(2) Oscillator regulating device

Adjustment of the oscillator of Cal. 4823A watch can be easily made by simply turning the trimmer condenser.

- Function of the Trimmer Condenser

The trimmer condenser consists of a rotor electrode and a stator electrode. Turning the shaft fixed to the rotor changes the overlapped area between the rotor electrode and stator electrode, which in turn changes the capacitance of the trimmer condenser. Turning the trimmer condenser changes its capacitance as shown in the diagram. Time is adjusted by the magnitude of this change.

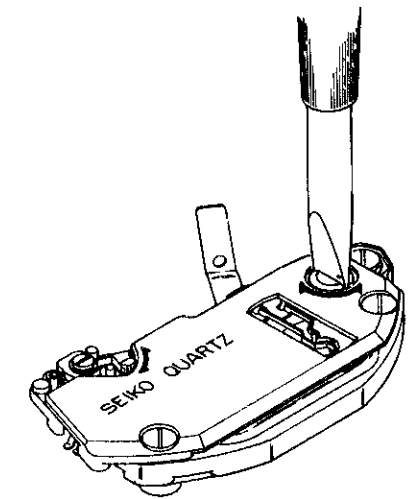

○ Checking accuracy cannot be made with conventional mechanical wrist-watch testers. It is necessary to use the QUARTZ TESTER.

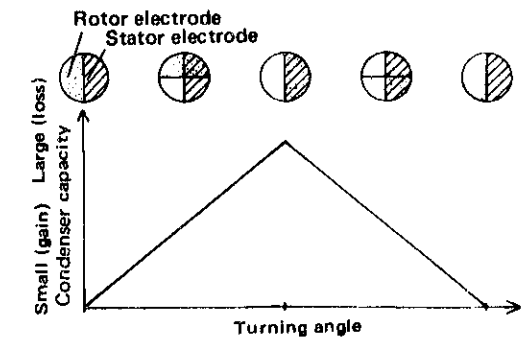
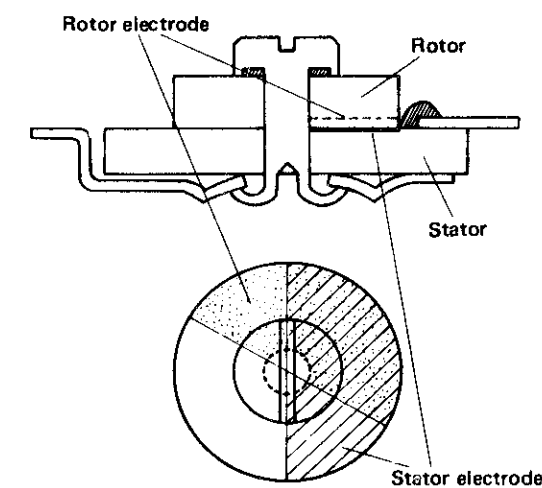

4. Functioning of mechanical portion

(1) Step motor

One of the features of these watches is the SEIKO step motor which changes the vibrations of the crystal oscillator into a rotating motion. The step motor consists of a coil block, a rotor stator and a step rotor. The rotor stator is made of materials having a high conductivity of magnetic force.

The step rotor is a circular-shaped permanent magnet having six alternately imposed N and S poles.

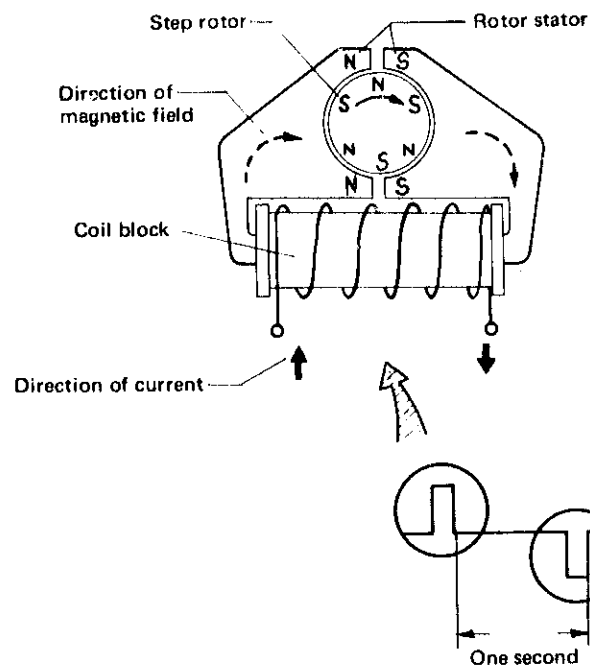
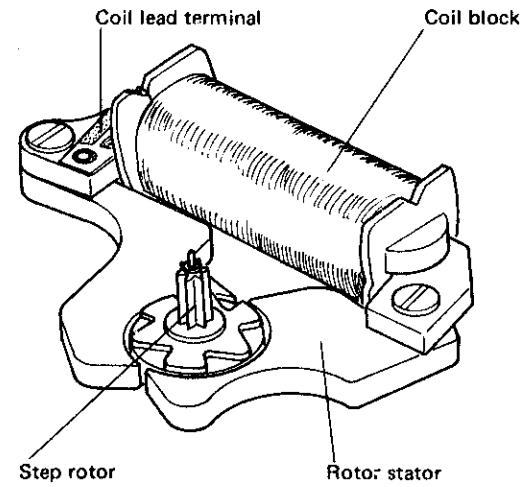

Operational sequence

- (1) Current flows in the coil block
The current, of which the flow direction is changed once every second, is transmitted from the circuit block into the coil block.
- (2) Rotor stator becomes magnet
When current flows in the coil block, the rotor stator becomes magnet and the tip portions become, respectively, N and S poles.
- (3) Step rotor rotations
The N and S poles of the rotor stator tips and the N and S poles of the step rotor alternately repel and attract causing

the step rotor to rotate in 60° increments in a constant direction once every second.

- (4) Rotation of the second hand
Rotation of the step rotor is transmitted to the fourth wheel and pinion which gears with the pinion of the step rotor. The rotation of the fourth wheel and pinion is finally transmitted to move the second hand.

(2) Second setting and reset switch

Cal. 4823A has the rapid advance second setting adjustment device and the reset switch for accurate time setting and second hand can

be set rapidly and accurately in accordance with the time signal.

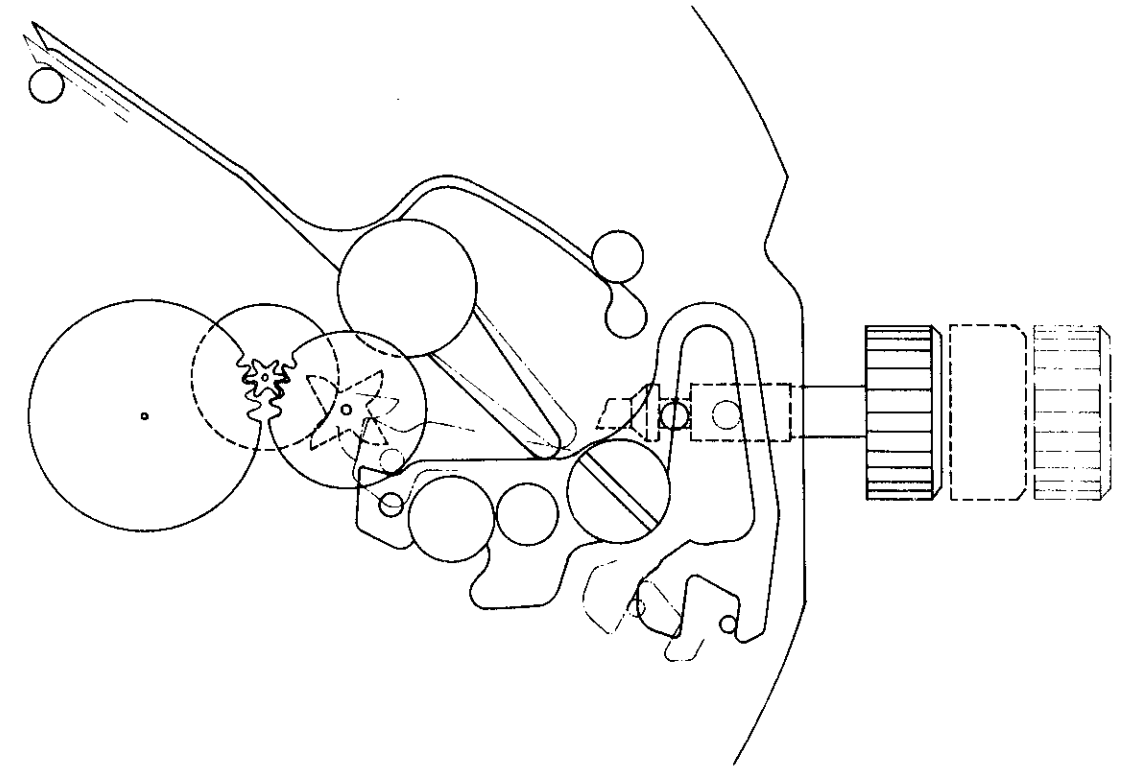

- Rapid advance second setting adjustment
When the crown is pulled out to the 2nd click, the driving pin for second setting lever will function to reset the cam of the second setting wheel. Thus, the second hand will stop at every 10 second position ahead (0, 10, 20, 30, 40, 50 second).
Ex. If the crown is pulled out to the 2nd click when the second hand is between 51 to 0 second position, the second hand will leap and stop at 0 second position.

- Reset switch
When the second setting lever functions and the second hand stops, the reset lever touches the circuit block reset pin and reset function starts.
The watch stops when the reset switch functions but the current from the battery flows to the crystal oscillator and a part of the electronic circuit and the watch is ready to restart.

III. HOW TO SET THE TIME AND CALENDAR

• Crown position

- Normal position: Free
- 1st click: Change of day and date
 - Date change . . . clockwise (turn away from you.)
 - Day change . . . counterclockwise turn toward you.)
- 2nd click: Hand setting, reset switch and second setting

1. Resetting time

- (1) Pull the crown out to the 2nd click and the second hand stops at every 10 second position ahead.
- (2) Turn the crown and set the time of the hour hand and minute hand.
 - First turn the hour hands past the 12 o'clock position to see if the date changes, then set the time correctly. (Allow for the AM & PM period so that the date will change at midnight.)
 - As the torque of the gear train is transmitted reversely, the time is set accurately by turning the hands between 5 to 10 minutes ahead and then turning it back to the desired time.

- (3) In accordance with the time signal, push the crown in. Rapid second adjustment facilitates easy time adjustment in accordance with the time signal of TV, radio and telephone.

Push the crown in to the innermost position to start the watch. Then the hour, minute and second hand can be set exactly.

2. Resetting calendar

- Pull the crown out to the 1st click. Select the desired language as two languages appear alternately when setting the day of the week.

If the setting of the calendar is made when the hour hand is pointing to the time between 9:30 pm and 2:00 am, sometimes the calendar will not change the next day. The setting must therefore be made before or after this time period.

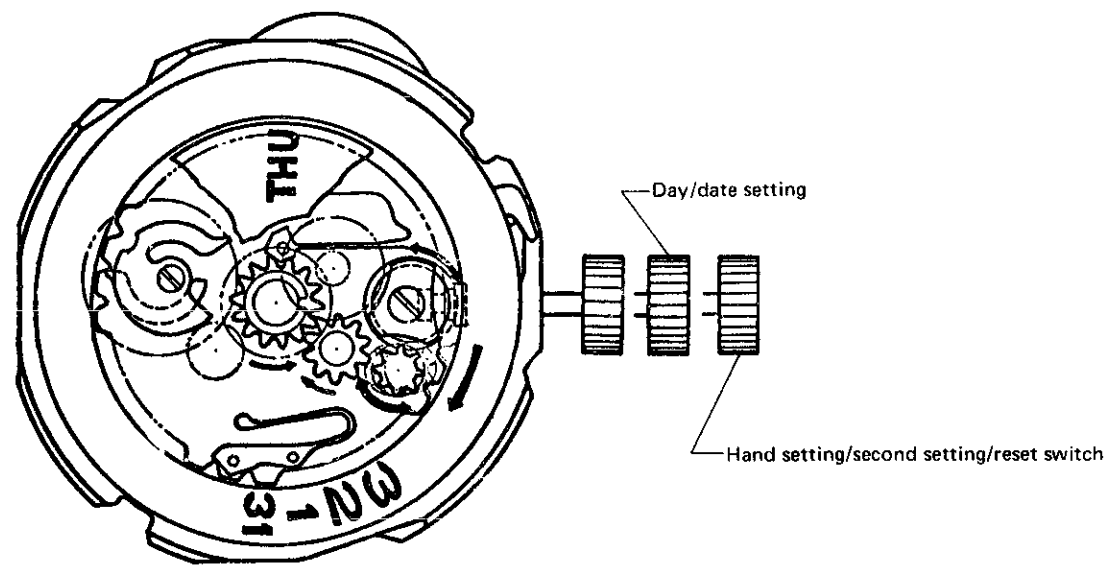

IV. CASE CONSTRUCTION

The case is water-resistant, and has the bayonet type battery hatch on the case back for easy battery replacement. There are two types of case construction, snap type case back and one-piece type.

Electric current flows from the (+) surface of the battery in the direction shown by the arrow mark (→).

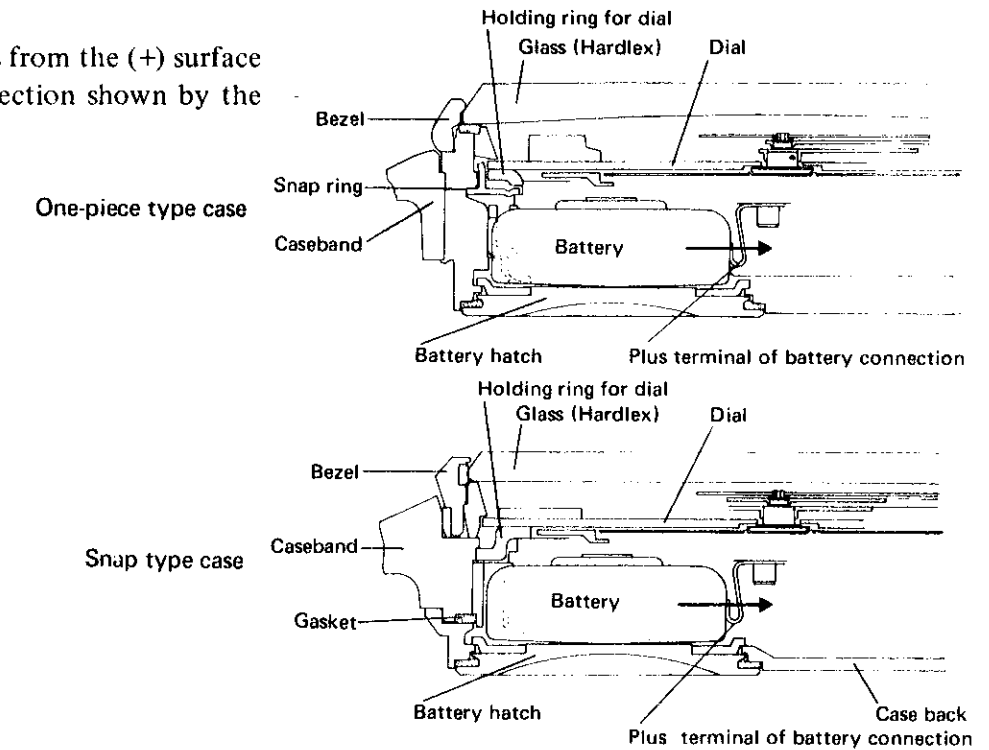

1. How to remove the movement from the one-piece type case

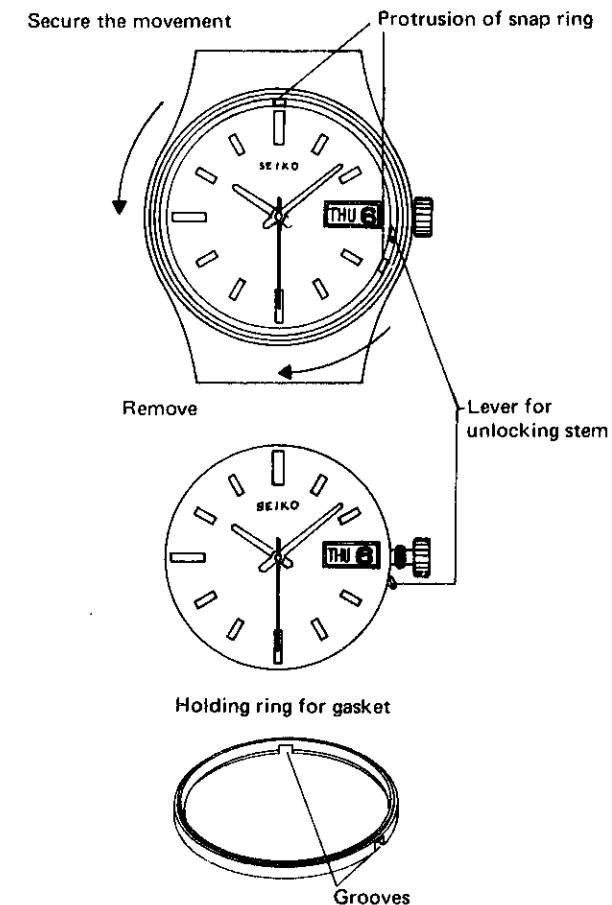

Turn the snap ring to remove the movement as it is fixed with the snap ring.

Although there are two protrusions of snap ring, one is located close to the dial of 4 o'clock position and the other is located close to the dial of 12 o'clock position, push the protrusion located at the 4 o'clock position toward the arrow-marked direction when turning the snap ring.

Push in the setting lever when the winding stem is pulled out.

Be careful not to scratch the outer circle of dial both when the snap ring is turned and the setting lever is pushed down as the clearance between the dial and the case is very small.

Turn the protrusion of snap ring located close to the dial of the 12 o'clock position toward the arrow-marked direction when re-assembling and tighten the movement.

When the holding ring for gasket is mounted on the dial, fit its groove to protrusions of snap ring.

V. AFTER-SALE SERVICING INSTRUMENTS AND MATERIALS

2. How to fix the snap type case back

• Alignment mark

Bring the line of both alignment mark on the caseband and case back in order to fix the case back as shown in the illustration, and then the battery hatch position is also fixed accordingly.

• Construction of the glass portion

The construction of the glass portion of the snap type case back of Cal. 4823 is shown in the illustration on page 9.

The "G" mark (water resistant G) is engraved on the snap type case back of Cal. 4823. (Snap type case back models are 4823-8029, 4823-8039 and 4823-8049 as of January 1976)

When disassembling and reassembling are needed, refer to the snap No. 4 of "Casing" item on the mechanical SEIKO watch Technical Guide Book.

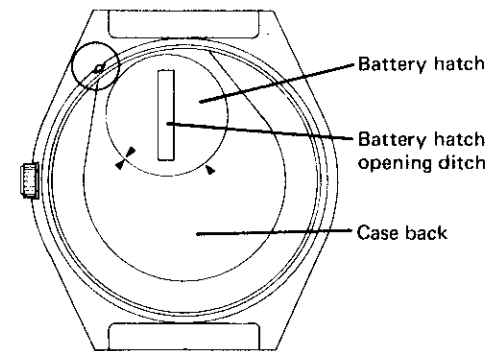

3. Battery replacement

The second hand will serve as a battery life indicator. The battery needs to be replaced when you see the second hand moving in two second interval instead of the normal one second interval. This indicates that the battery life will expire in one week. The watch, however, remains accurate during the one week period.

All the models of Cal. 4823 are equipped with a bayonet type battery hatch for easy replacement of the battery.

Remarks:

The battery does not come out by itself from the battery housing when the battery hatch is opened as the battery is held with a battery connection spring.

Therefore, remove the battery by using non-metallic tweezers.

For repair servicing, the following SEIKO after-sale servicing instruments and materials are necessary.

These instruments and materials are available at the head office of SEIKO.

1. Quartz Tester

Used to check time accuracy (daily rates) and flow of current from circuit block.

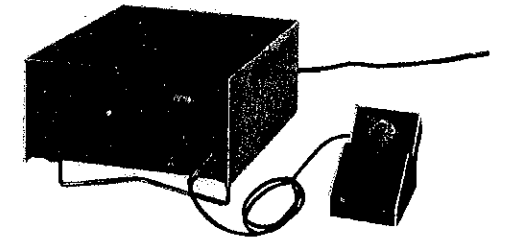

Quartz tester

2. Volt-ohm-meter

Used for checking battery voltage, measuring resistance and conducting conductivity test.



Volt-ohm-meter

3. Movement holder (S-651)

Used for disassembling, reassembling, checking and adjusting the movement.

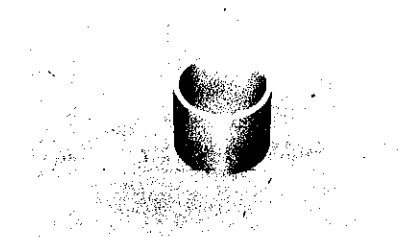

Movement holder S-651

4. Others

- (1) Anti-magnetic tweezers for handling step rotor.
- (2) Non-metallic tweezers for handling battery.

VI. DISASSEMBLING, REASSEMBLING, LUBRICATING AND CLEANING

1. Disassembling, Reassembling and Lubricating

- Disassembling and Reassembling

Disassembling procedures Figs.: ① → ④⑨

Reassembling procedures Figs.: ④⑨ → ①

- For the items marked with ▶ in disassembling and reassembling diagrams, refer to "CHECKING AND ADJUSTMENT".

(1) Disassembling, reassembling and lubricating of the calendar and setting mechanism

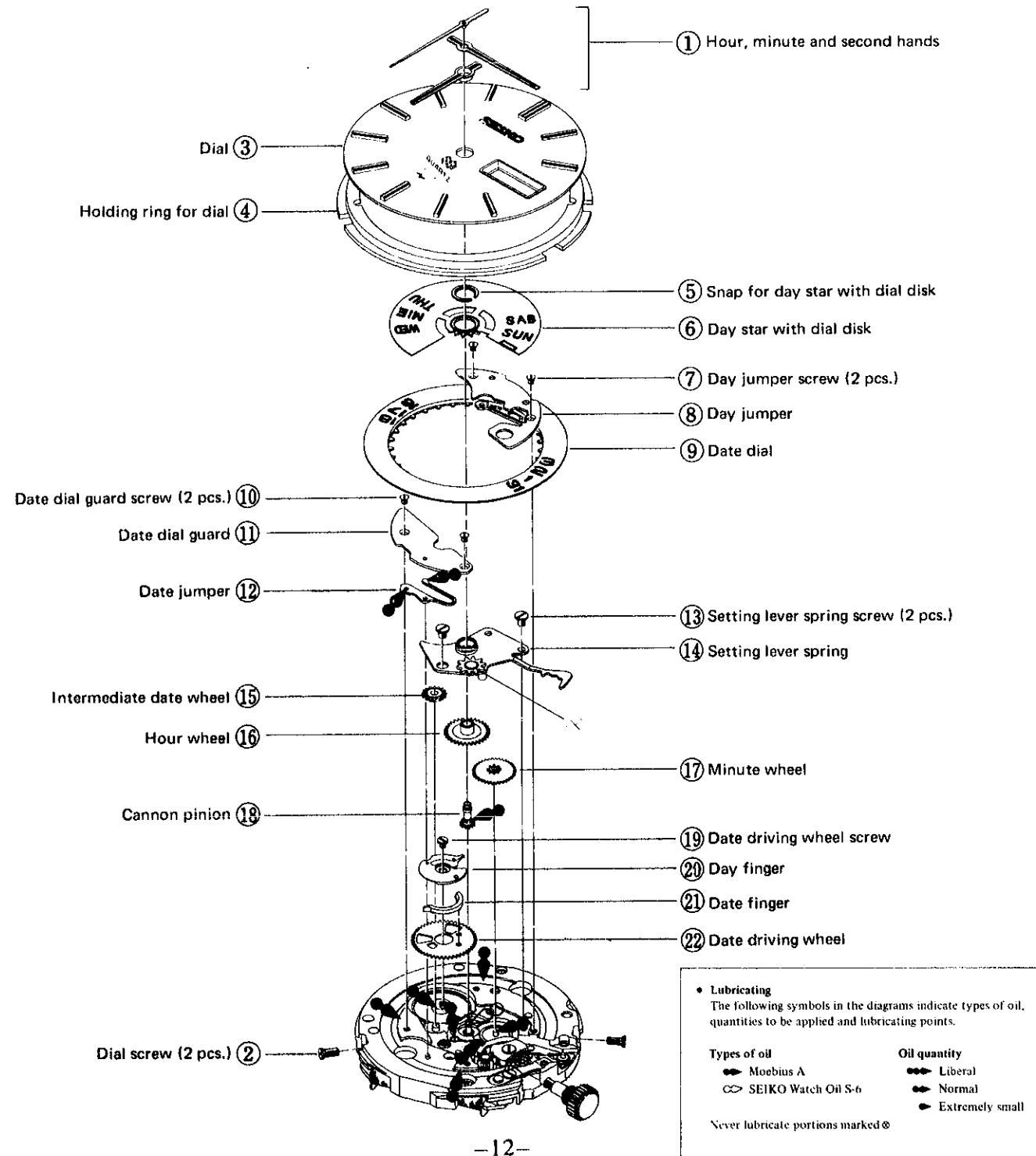

Remarks for disassembling and reassembling:

Hour, minute and second hands ①

- Pull out the crown to the 2nd click before putting on or removing the hands.
- Put the second hand just on the ten-second mark (0, 10, 20 . . . 50 sec.).
- After placing the second hand, follow the procedures:

K CHECK SECOND SETTING CONDITION and **L** CHECK RESET CONDITION.

Holding ring for dial ④

Set up these two parts for easy reassembling work.

Setting lever spring ⑭

- After reassembling check the crown condition (operation by pulling out and pushing in), reset conditions, hand-setting conditions.
- Intermediate wheel for day correction (it is touched to the setting lever spring.)

Hour wheel ⑯

Reassembling the hour wheel so that it doesn't touch the day finger.

Date driving wheel ⑳

In reassembling, do not mistake the obverse and reverse for each other.

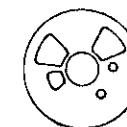

Front

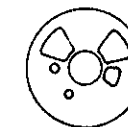

Back