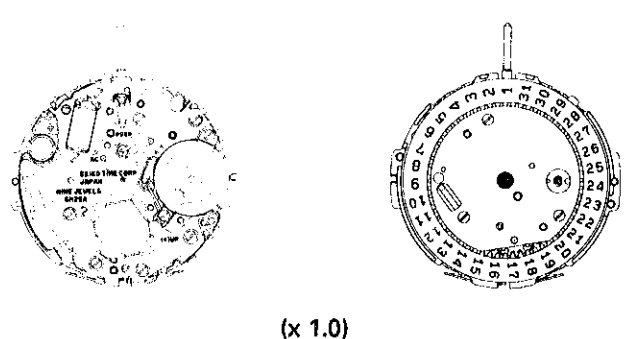

PARTS CATALOGUE/TECHNICAL GUIDE

Cal. 6M25A

[SPECIFICATIONS]

		Cal. No.	6M25A
Item			
Movement		 <p>(x 1.0)</p>	
Movement size	Outside diameter	28.5 mm between 6 o'clock and 12 o'clock sides ø27.0 mm between 3 o'clock and 9 o'clock sides	
	Casing diameter	ø26.4 mm	
	Height	3.9 mm	
Time indication		3 hands and mode indicator	
Driving system		Step motor (4 pcs.)	
Additional mechanism		<ul style="list-style-type: none"> • Alarm function (12-hour indication system) • Countdown timer (Up to 60 minutes) • Stopwatch function (Up to 60 minutes in 1/10 seconds) • Month and date (Automatic calendar) • Hands 0-reset adjustment function • Alarm test system • Demonstration movement of the hands • Electronic circuit reset switch • Battery life indicator 	
Loss/gain		Monthly rate at normal temperature range: less than 15 seconds	
Regulation system		Nil	
Measuring gate by quartz tester		Use 10-second gate (in "CHRONO Ø" mode).	
Battery		SEIKO SR927W, Maxell SR927W, SONY SR927W, EVEREADY 399 Battery life is approximately 2 years. Voltage: 1.55V	
Jewels		9 jewels	

SEIKO CORPORATION

PARTS CATALOGUE

Cal. 6M25A

Disassembling procedures Figs. : (1) → (57)

Reassembling procedures Figs. : (57) → (1)

Lubricating: Types of oil Oil quantity

- Silicone Oil 500,000 c.s. ○ Normal quantity
- Moebius A
- SEIKO Watch Oil S-6

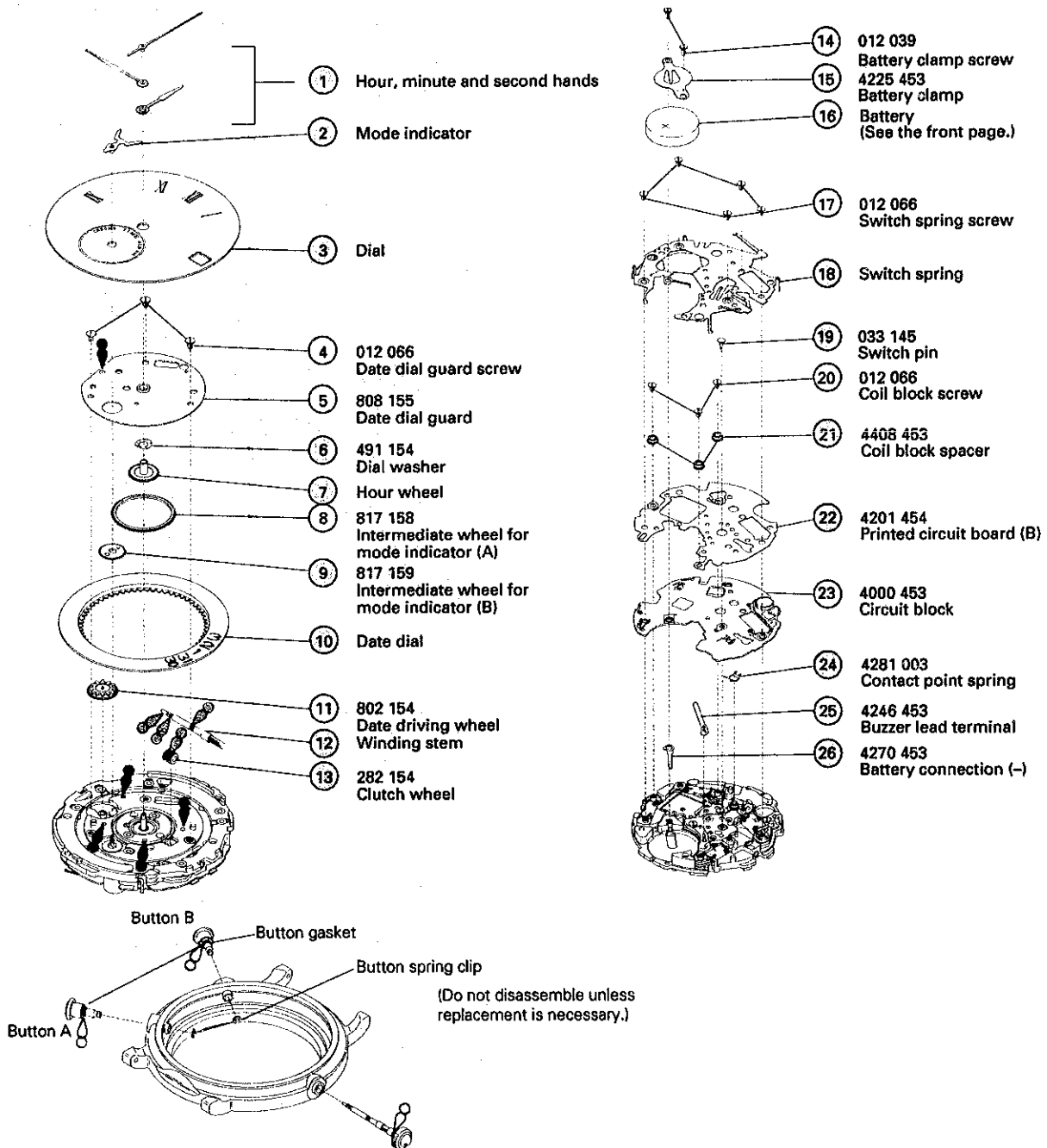

○ → Please see the remarks on the following pages.

PARTS CATALOGUE

Cal. 6M25A

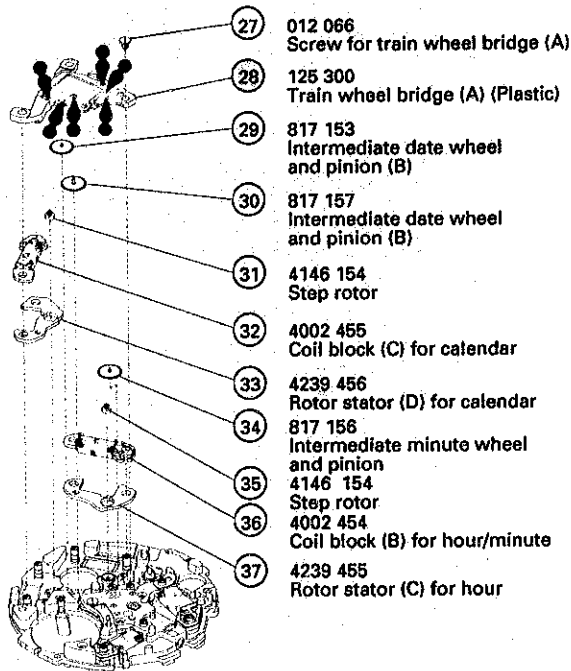

- 27 012 066
Screw for train wheel bridge (A)
- 28 125 300
Train wheel bridge (A) (Plastic)
- 29 817 153
Intermediate date wheel
and pinion (B)
- 30 817 157
Intermediate date wheel
and pinion (B)
- 31 4146 154
Step rotor
- 32 4002 455
Coil block (C) for calendar
- 33 4239 456
Rotor stator (D) for calendar
- 34 817 156
Intermediate minute wheel
and pinion
- 35 4146 154
Step rotor
- 36 4002 454
Coil block (B) for hour/minute
- 37 4239 455
Rotor stator (C) for hour

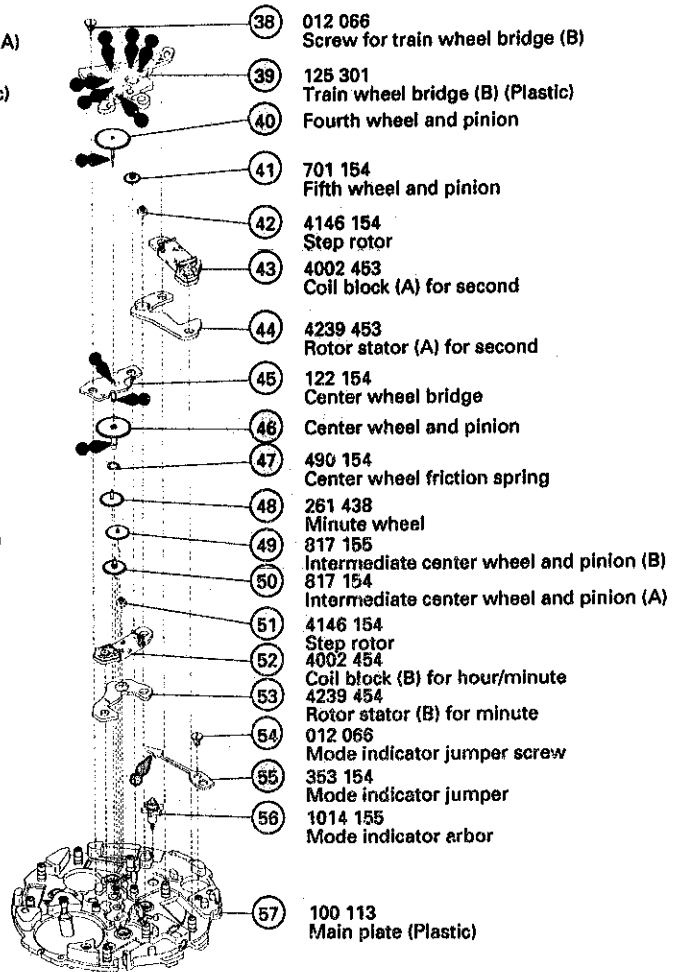

- 38 012 066
Screw for train wheel bridge (B)
- 39 125 301
Train wheel bridge (B) (Plastic)
- 40 Fourth wheel and pinion
- 41 701 154
Fifth wheel and pinion
- 42 4146 154
Step rotor
- 43 4002 453
Coil block (A) for second
- 44 4239 453
Rotor stator (A) for second
- 45 122 154
Center wheel bridge
- 46 Center wheel and pinion
- 47 490 154
Center wheel friction spring
- 48 261 438
Minute wheel
- 49 817 155
Intermediate center wheel and pinion (B)
- 50 817 154
Intermediate center wheel and pinion (A)
- 51 4146 154
Step rotor
- 52 4002 454
Coil block (B) for hour/minute
- 53 4239 454
Rotor stator (B) for minute
- 54 012 066
Mode indicator jumper screw
- 55 353 154
Mode indicator jumper
- 56 1014 155
Mode indicator arbor
- 57 100 113
Main plate (Plastic)

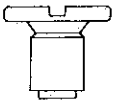
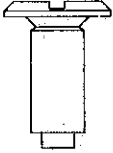
	<p>012 066</p> <ul style="list-style-type: none"> • Date dial guard screw (3 pcs.) • Switch spring screw (5 pcs.) • Coil block screw (3 pcs.) • Screw for train wheel bridge (A) (1 pc.) • Screw for train wheel bridge (B) (1 pc.) • Mode indicator jumper screw (1 pc.)
	<p>012 039</p> <ul style="list-style-type: none"> • Battery clamp screw (2 pcs.)

 Please see the remarks on the following pages.

PARTS CATALOGUE

Cal. 6M25A

Remarks:



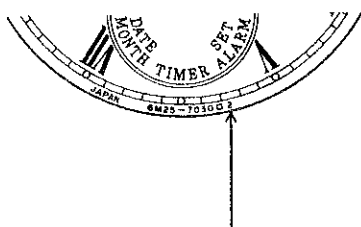
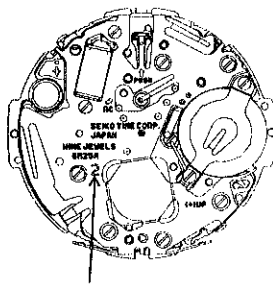

- ⑦ Hour wheel
- ④⑩ Fourth wheel and pinion
- ④⑥ Center wheel and pinion

• **Discrimination of the installing height of the hands**

Cal. 6M25A watches have numerals printed on the dial and movement to indicate the installing heights of hands. When repairing, refer to the table below.

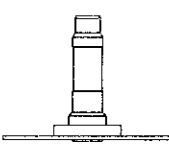
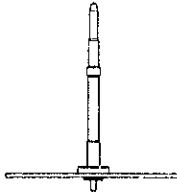
Discrimination	Height	Standard type	Long type
	Numeral for discrimination	2	3
Printed on		Dial	Movement
Printed position		 <p>The numeral is printed at the right end.</p>	 <p>The numeral is printed below the calibre number.</p>

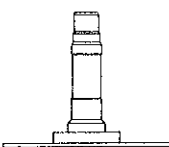
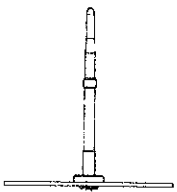
* The installing heights of the hands can be known from the shape of the following parts. Refer to the table below.

Numeral for discrimination	Center wheel and pinion	Fourth wheel and pinion	Hour wheel
2	 <p>221 154</p>	 <p>241 154</p>	 <p>271 438</p>
3	 <p>221 155</p>	 <p>241 155</p>	 <p>271 439</p>

PARTS CATALOGUE

Cal. 6M25A

⑩ Date dial

Part code	Position of crown and calendar	Color of figure	Color of background
801 451	3 o'clock	Black	White

The type of date dial is determined based on the design of cases.
Check the case number and refer to "SEIKO CASING PARTS CATALOGUE" to choose a corresponding date dial.

⑫ Winding stem 351 168

The type of winding stem is determined based on the design of cases.
Check the case number and refer to "SEIKO CASING PARTS CATALOGUE" to choose a corresponding winding stem.

⑱ Switch spring

- 4245 456 : Use with the movement having the discrimination numeral "2".
- 4245 457 : Use with the movement having the discrimination numeral "3".

• Piezoelectric element

4589 650

TECHNICAL GUIDE

Cal. 6M25A

- The explanation here is only for the particular points of Cal. 6M25A.
- For the repairing, checking and measuring procedures, refer to the "TECHNICAL GUIDE, GENERAL INSTRUCTIONS".

I. STRUCTURE OF THE CIRCUIT BLOCK

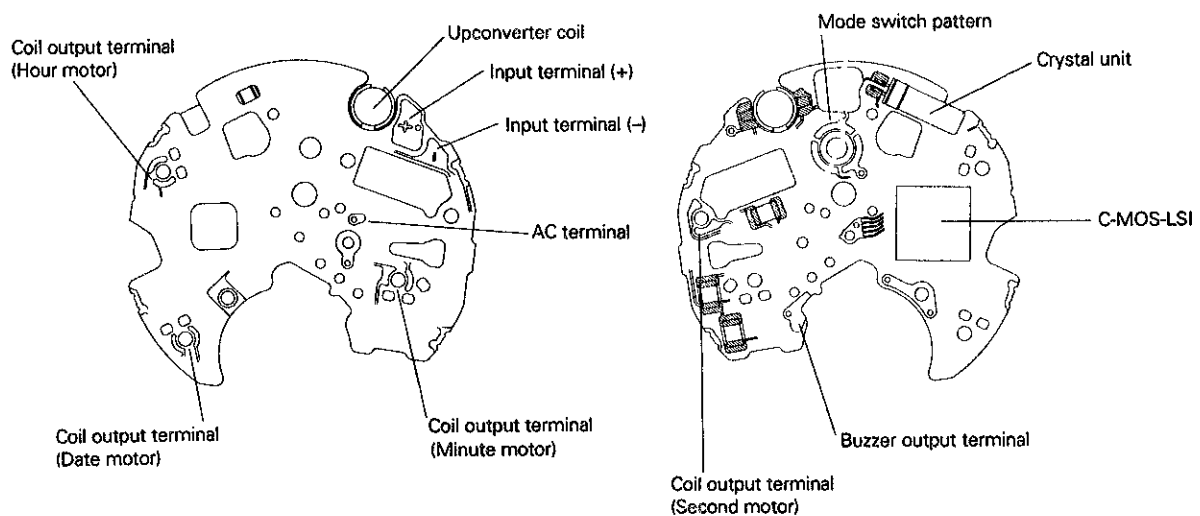

II. REMARKS ON INSTALLING THE BATTERY

- After the battery is replaced with a new one, or after the battery is re-installed following the repairing procedures, be sure to short-circuit the AC terminal of the circuit block and the battery connection (+) with conductive tweezers to reset the circuit as shown in the illustration below.
(When checking the current consumption, short-circuit with the power supplied from external source.)

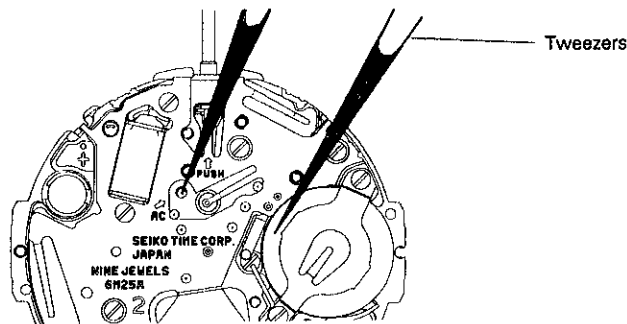

- To reset the circuit of the complete watch, follow the procedure below.

- (1) Turn the crown to set the mode indicator to "CHRONO Ø".
- (2) Pull out the crown to the first click.
- (3) Keep buttons "A" and "B" pressed at the same time for approximately 2 seconds. When the buttons are released, a beep sounds and the hour and minute hands start moving counterclockwise and clockwise, respectively. The second hand moves back and forth.

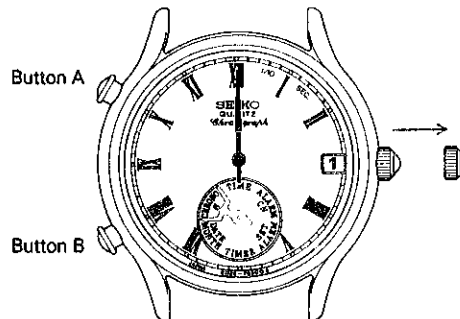

- (4) Press button "A" or "B" once to stop the hands.
- (5) Press button "A" to select the hand or date to be adjusted in the following order.



* The hand selected to be adjusted will move back and forth and return where it was. The date will advance one day and return to the current date if selected.

- (6) Press button "B" to reset the selected hand to the "12" o'clock position and set the date to "1".
* The hands and date move quickly if the button "B" is kept pressed for 2 seconds.

- (7) Push the crown back in to the normal position.

- After all the adjustments for resetting the circuit are completed, turn the crown to set the mode indicator to "TIME" to set the desired time, turn it to "ALARM SET" to set the alarm, and turn it to "DATE MONTH" to set the desired month and date.

* The time can also be set by setting the mode indicator to "ALARM ON".

III. REMARKS ON DISASSEMBLING AND REASSEMBLING

Use the universal movement holder for disassembling and reassembling.

① Hands

Since a plastic main plate is used, place the movement on a flat metal plate or the like, and then install the hands at the 12 o'clock position.

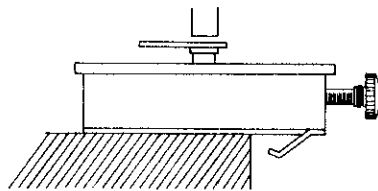

② Mode indicator

• How to remove

Set a hand-removing jig at the center of the mode indicator to remove it. In doing so, check that the hand-removing jig is set right at the center of the mode indicator. Otherwise, the mode indicator may be deformed.

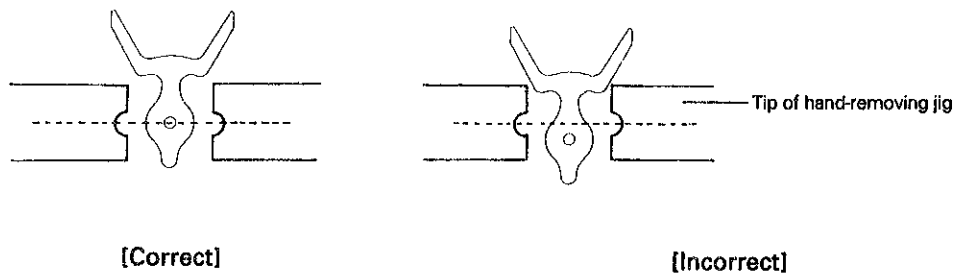

• How to install

Place the movement on a flat metal plate or the like, and then set the mode indicator and the mode indicator arbor following the procedure below.

- (1) Turn the crown to set the notched portion of the mode indicator arbor at the 6 o'clock position.

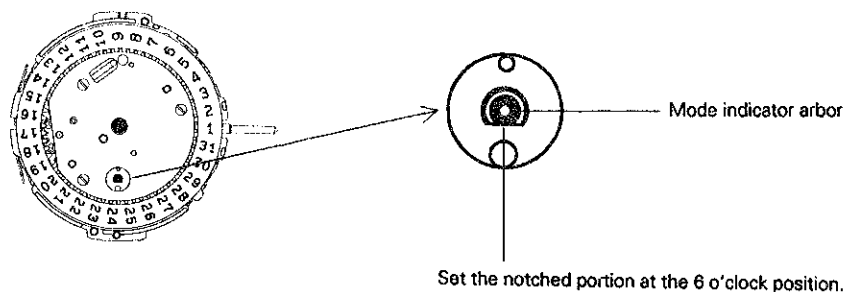

TECHNICAL GUIDE

Cal. 6M25A

(2) Install the mode indicator so that it points to "TIME".

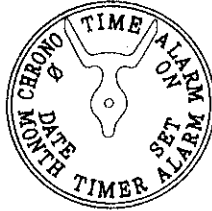

(3) After installing the mode indicator, give it three full turns by turning the crown to check if it stops exactly at the respective mode positions.

If the mode indicator arbor is loose in the contact with the mode indicator's pipe, the mode indicator will stop out of the proper positions. In that case, slightly flatten the mode indicator's pipe at the part indicated in the illustration, and then install the mode indicator to the mode indicator arbor again.

Mode indicator's pipe (Flatten here.)

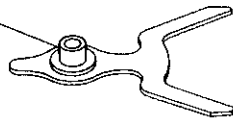

③ Dial

Pry up the dial at the two recessed parts indicated in the illustration using a screwdriver.

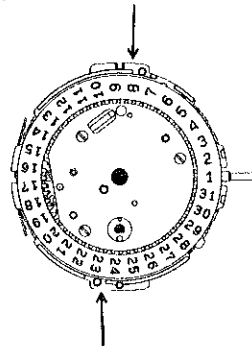

⑥ Dial washer

④⑦ Center wheel friction spring

• How to distinguish the two parts

[Dial washer]

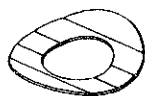

• With the larger diameter

[Center wheel friction spring]



• With the smaller diameter

• Setting position

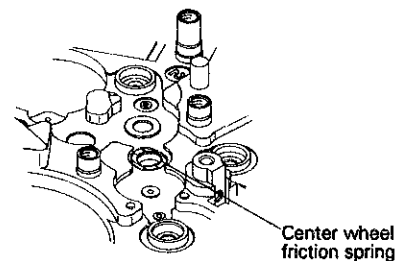

Center wheel friction spring

⑨ Intermediate wheel for mode indicator (B)

• How to install

Set the intermediate wheel for mode indicator (B) to the mode indicator arbor so that it fits in with the notched part of the mode indicator arbor.

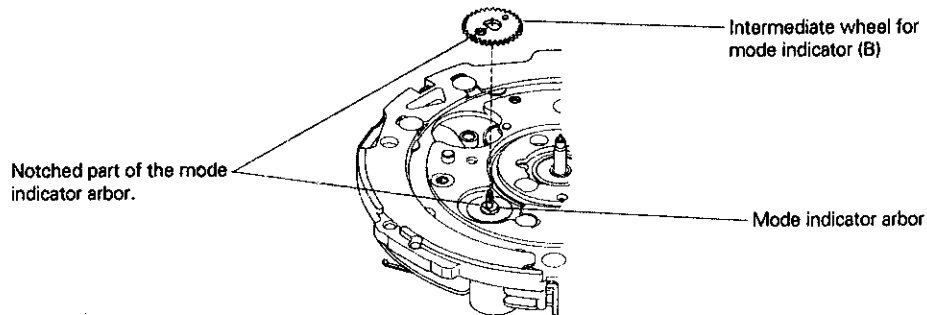

⑩ Date dial

• How to install

Since a plastic date dial is used, make sure that the teeth of the date dial and the date driving wheel securely mesh with each other.

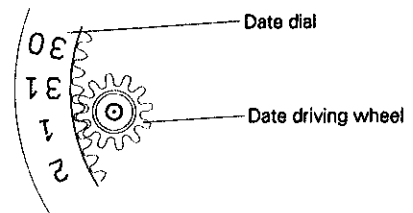

⑫ Winding stem

• How to remove

Remove the winding stem while pushing the indented portion of the switch spring (marked with "← PUSH").

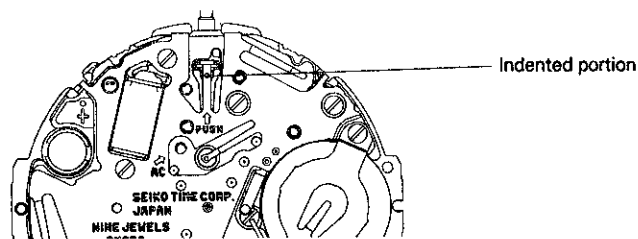

⑬ Clutch wheel

• How to install

Be sure to install the clutch wheel in the direction as shown in the illustration.

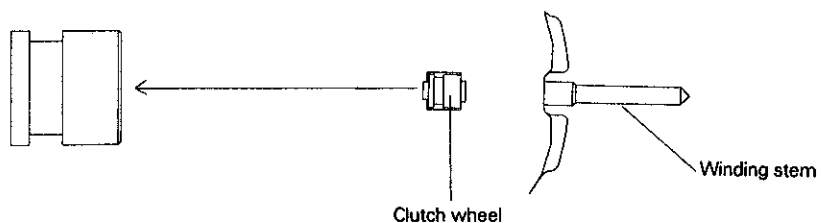

18) Switch spring

• How to install

Set the three hooking portions of the switch spring to the main plate.

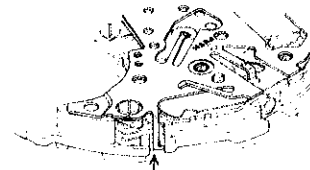
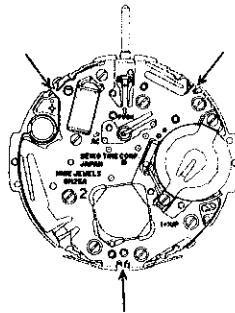

Take care not to deform the switch spring when disassembling or reassembling it.

19) Switch pin

Check that proper clearance is provided between the switch pin and circuit block.

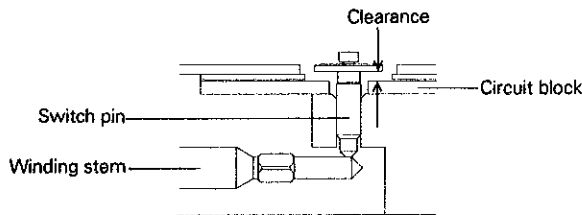

Crown at the normal position : Clearance provided.
 Crown at the first click: No clearance provided.

21) Coil block spacer

• How to install

Two types of coil block spacers are available, and they can be used interchangeably. Take care not to install up side down.

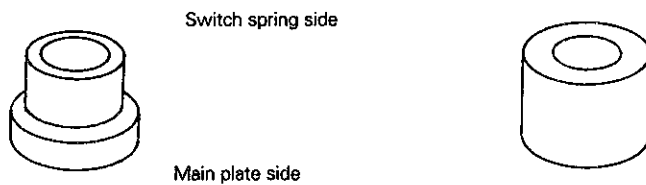

Install in either direction.

22) Printed circuit board (B)

• How to remove

Catch the protrusion of the printed circuit board and pull it up to remove.

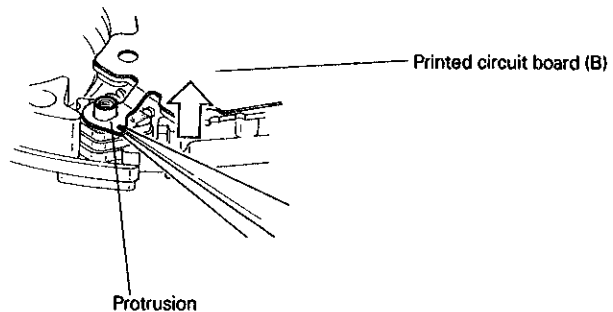

24 Contact point spring
• **Setting position**

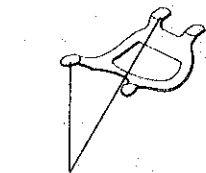

Check if the contacting portion with the circuit block is deformed.

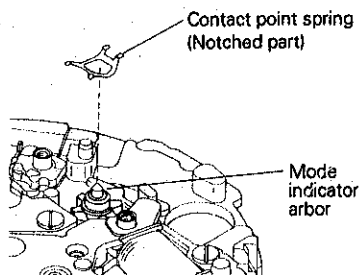

Set the contact point spring to the mode indicator arbor so that it fits in with the notched part of the mode indicator arbor.

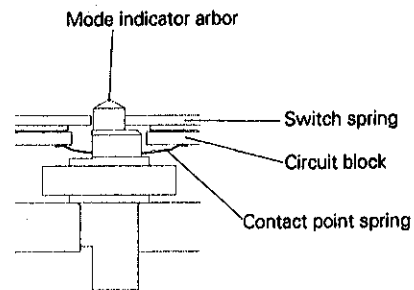

26 Battery connection (-)

• **How to install**

Set the battery connection (-) along the guide groove of the main plate.

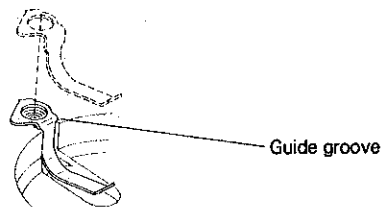

28) Train wheel bridge (A) (Plastic)

• **Setting position**

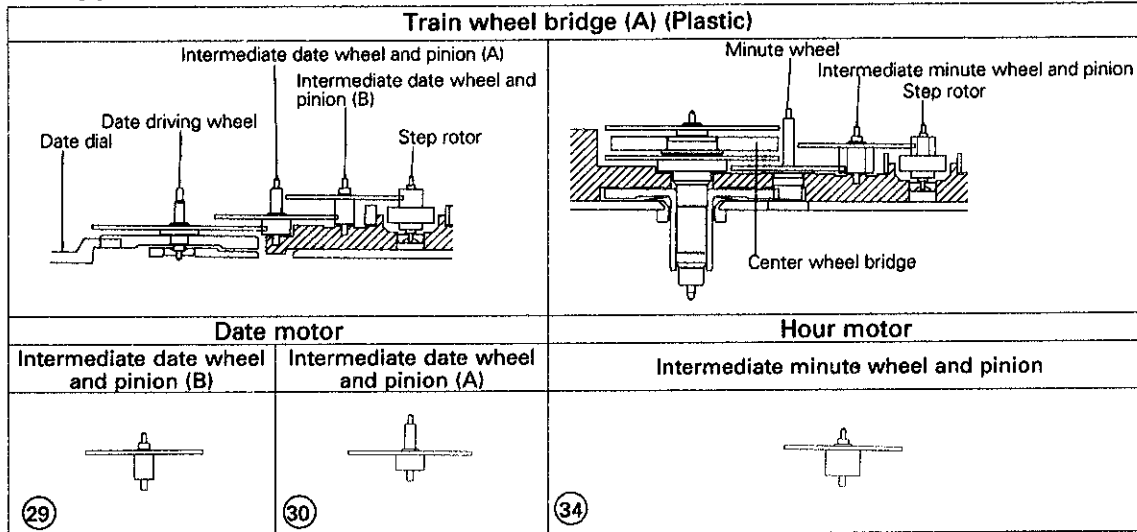

39) Train wheel bridge (B) (Plastic)

• **Setting position**

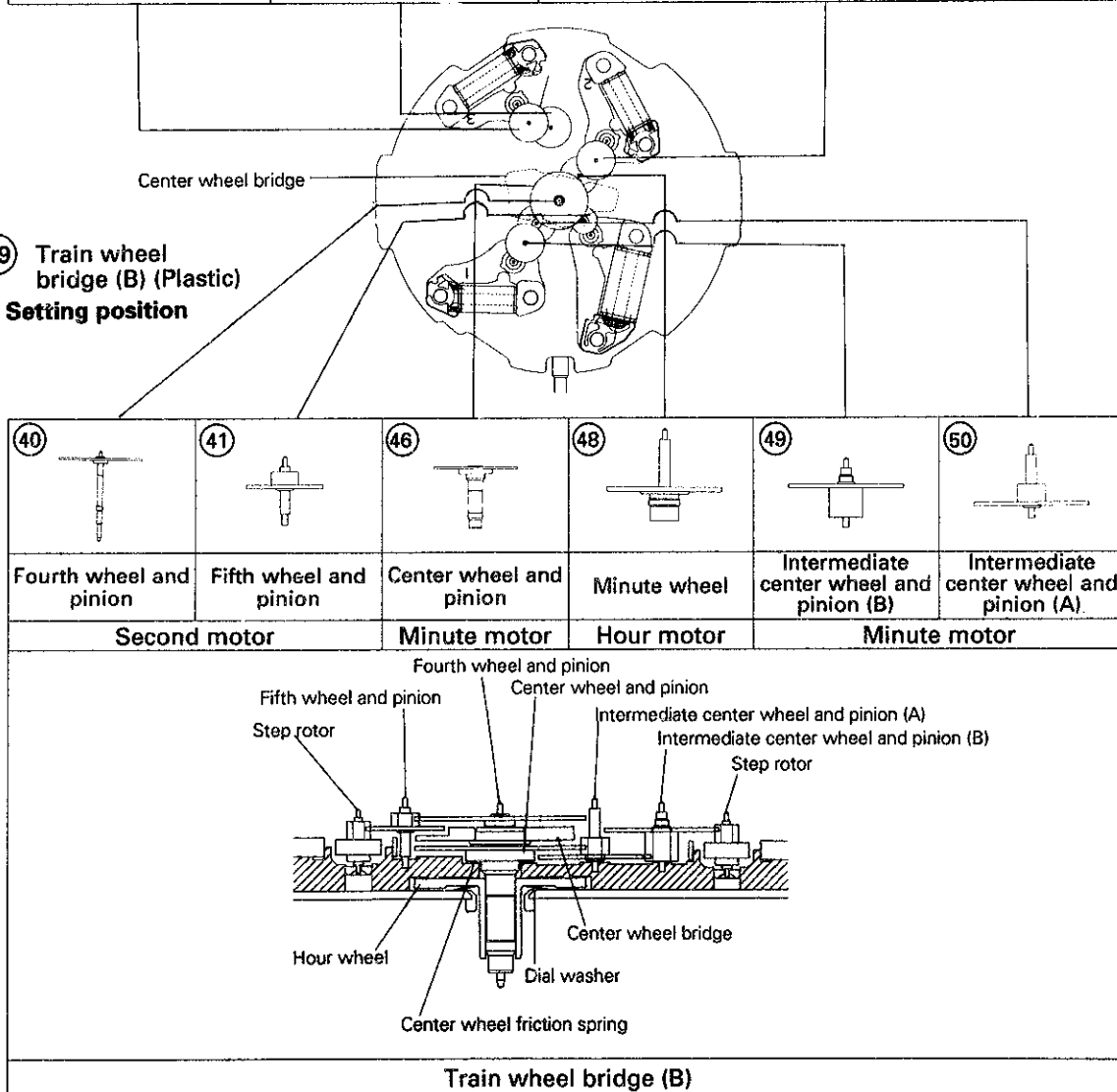





* For the distinction of parts of respective motors, see the next page.

TECHNICAL GUIDE

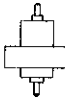
Cal. 6M25A

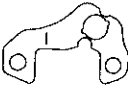
• **Distinction of motors**

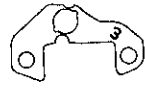
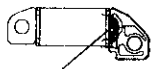
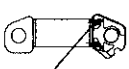
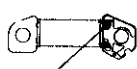
Distinction Part name	Second motor	Minute motor	Hour motor	Date motor
Step rotor				
Rotor stator	 No mark	 Marked with "1"	 Marked with "2"	 Marked with "3"
Coil block	 Mold agent: Blue Larger diameter	 Mold agent: Green Standard diameter	 Mold agent: Red Smaller diameter	

⑤ Mode indicator jumper

Take care not to deform the mode indicator jumper when disassembling or reassembling it, as extremely high pressure is applied to it.

• **How to remove**

Release the tip of the mode indicator jumper from the mode indicator arbor, and then lift up "A" portion in the illustration.

• **How to install**

Reverse the procedures for disassembling.

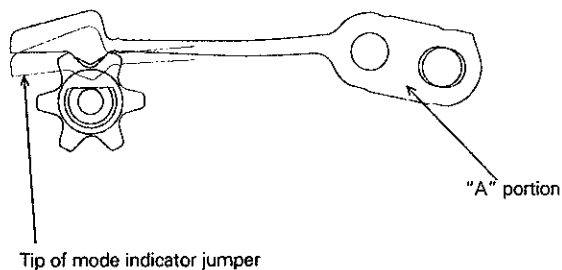

IV. VALUE CHECKING

• Coil block resistance

Coil block for second motor	:	1.5K Ω ~ 1.9K Ω
Coil block for minute and hour motor	:	1.2K Ω ~ 1.6K Ω
Coil block for date motor	:	0.8K Ω ~ 1.2K Ω

• Upconverter coil resistance

120 Ω ~ 180 Ω

• Measuring time accuracy

- [1] Turn the crown to set the mode indicator to "CHRONO \emptyset ".
* When the stopwatch is counting, press button "A" to stop the measurement and then press button "B" to reset the hands.
- [2] Set the gate of the quartz tester to "10" and then put the watch on the microphone.

Note:

To measure the time accuracy, be sure to set the watch in the "CHRONO \emptyset " mode and check that the stopwatch has been reset. A small amount of output signal is constantly generated for the measurement use. If the measurement is made in the "TIME" mode with the hands moving, no stable measurement can be obtained.

• Current consumption

For the whole of the movement	:	less than 3.0 μ A
For the circuit block alone	:	less than 0.8 μ A

- [1] Tighten the two battery clamp screw, and install the dial, hands and mode indicator.
- [2] Turn the crown to set the mode indicator to "TIME", and supply the power from the external source.
- [3] Short-circuit the AC terminal of the circuit block and the switch spring twice to reset the circuit.
- [4] Press button "A" or "B" to set the hands moving, and then measure the current consumption.

Note:

The motors move the hands and date calendar at the following intervals.

- Second motor: 1-second intervals
- Minute motor : 10-seconds intervals
- Hour motor : 2-minutes intervals
- Date motor : 24-hours intervals

Calculate the current consumption following the formula below.

$$\text{Current consumption of second motor} + \frac{\text{Current consumption of minute motor} - \text{Current consumption of second motor}}{10^*} = \text{Current consumption of movement}$$

(Ex.)

$$1.5 (\mu\text{A}) - \frac{2.5 (\mu\text{A}) - 1.5 (\mu\text{A})}{10} = 1.6 (\mu\text{A})$$

* The value of the numerator represents the current consumption of the minute motor, which moves at 10-second intervals. To obtain the current consumption to a second, it should be divided by "10".

Note:

To obtain the current consumption of the movement, it is necessary to add up the measured values of all the motors by converting them to the values to a second. However, the hour and minute motors' current consumption to a second is so small that it will not affect the aggregate of the current consumption. Therefore, it is safely assumed that the above formula represents the current consumption of the movement.