

SEIKO

DIGITAL QUARTZ

Cal. A128A

PARTS LIST

Cal. A128A

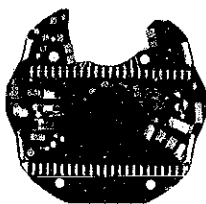
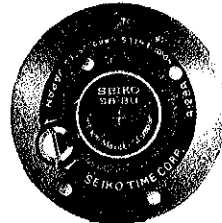

4001 884



4033 884



4245 880



4313 880

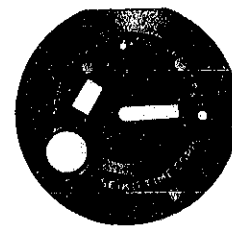

4410 886



4510 920



4521 510



4521 511



4540 880



☆ SEIKO SB-BU

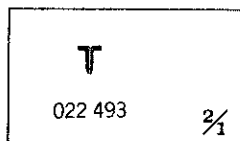

022 493

$\frac{2}{1}$

Cal. A128A

Characteristics

Casing diameter : ϕ 28.9 mm
 Maximum height : 7.0 mm
 Frequency of quartz crystal oscillator : 32,768 Hz (Hz = Hertz Cycle per second)
 Time functions : Digital Display System showing hour, minute, second and day
 Calendar functions : Digital Display System showing month, day and date
 Chronograph functions : 12-hour Digital Display System showing minute and second (or minute, second and 1/10 second within 20 minutes measurement)
 Display medium : Nematic Liquid Crystal, FE-Mode
 Time micro adjustor : Trimmer condenser system
 Illuminating light : Illuminates all the digital displays in the dark by depressing the light button.
 Battery life indicator : All the digits in the display begin flashing.

PART NO.	PART NAME	PART NO.	PART NAME
4001 884	Circuit block		
4033 884	Liquid crystal panel frame (with bulb)		
4245 880	Switch spring		
4313 880	Connector		
4410 886	Circuit bridge plate		
4510 920	Liquid crystal panel		
4521 510	Reflecting mirror (Silver)		
4521 511	Reflecting mirror (Gold)		
4540 880	Liquid crystal panel holder		
022 493	Liquid crystal panel holder screw		
☆SEIKO SB-BU ☆Maxell SR1130W	} Silver oxide battery		

Remarks :

☆Battery The applied battery for this calibre might be added the substitutive in the future. In that case, please refer to separate "BATTERIES FOR SEIKO QUARTZ WATCHES".

☆⇨ Please see remarks.

Part numbers in light letters are not shown in photos.

TECHNICAL GUIDE

SEIKO

DIGITAL QUARTZ

CAL. A128A

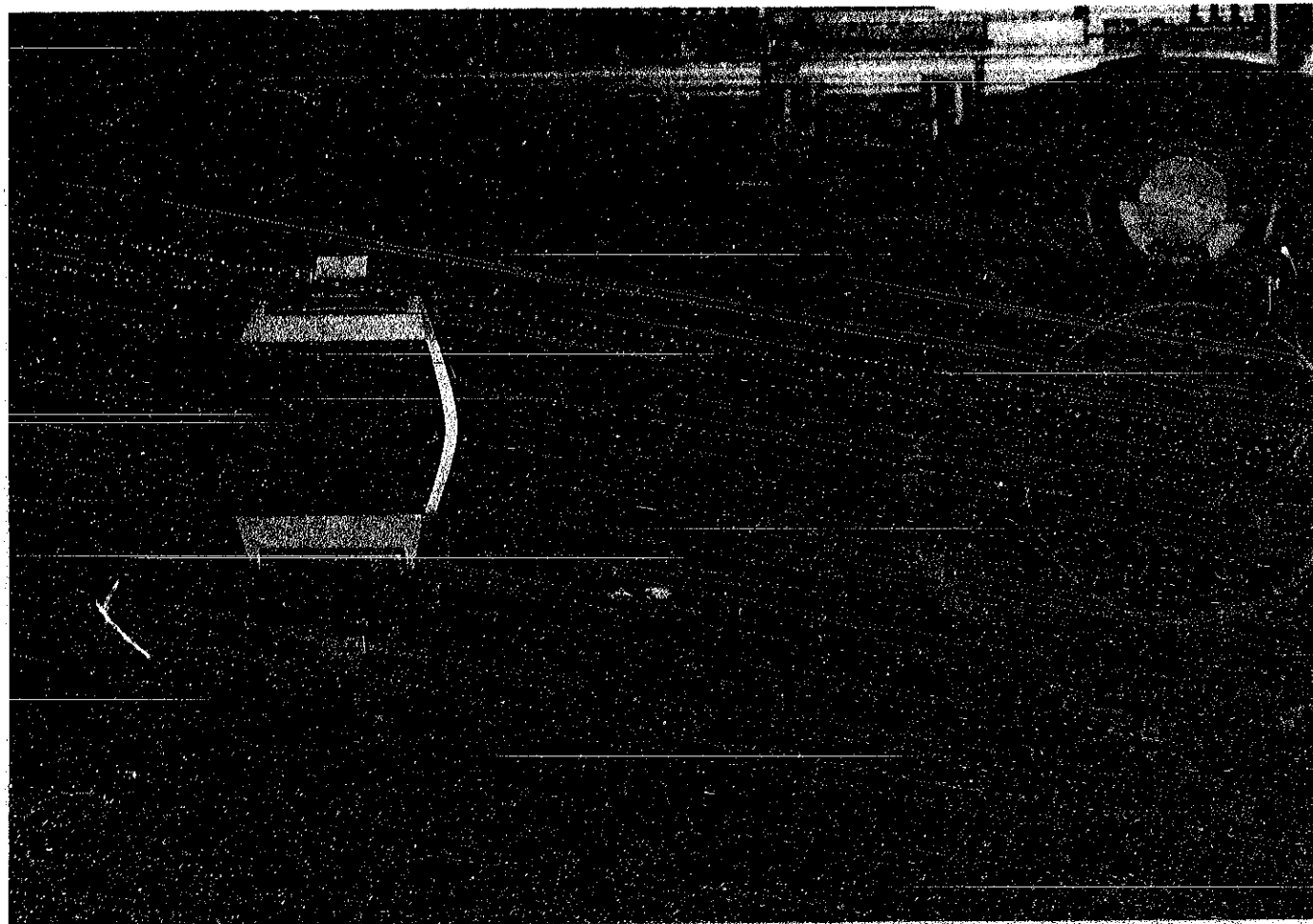

CONTENTS

I. SPECIFICATIONS AND FEATURES	1
1. Specifications	1
2. Features	1
II. HOW TO USE	2
1. How to set the time and calendar	3
2. How to use as a stopwatch	4
III. DISASSEMBLING AND REASSEMBLING	5
1. Disassembling and reassembling of the case	5
2. Disassembling and reassembling of the module	8
3. Cleaning	10
IV. CHECKING AND ADJUSTMENT	11
1. Guide table for checking and adjustment	11
2. Malfunction and checking points	12
3. Relationship between the segment (Liquid Crystal Panel Electrode) and the C-MOS-LSI output terminal	13
4. Procedures for checking and adjustment	14
A. Check battery voltage	14
• How to check battery electrolyte leakage and repair	14
• Check pattern segment checking system	15
B. Check contact of C-MOS-LSI and liquid crystal panel	15
C. Check liquid crystal panel and circuit block	16
D. Check current consumption	17
E. Check accuracy	18
F. Check functioning and adjustment	18
G. Check bulb condition	19
H. Check conductivity of switch components	20

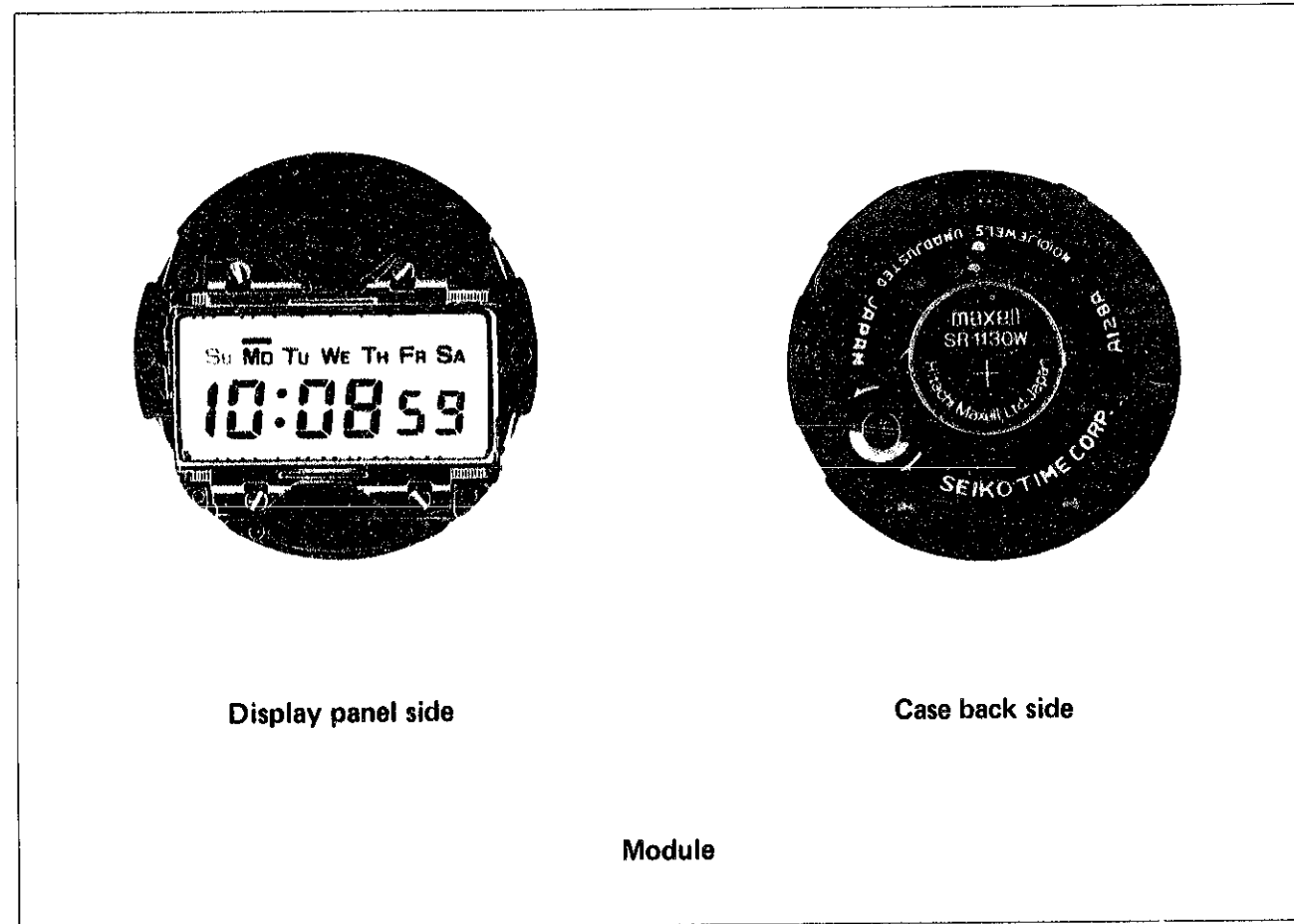

I. SPECIFICATIONS AND FEATURES

1. Specifications

Item	Calibre No. A128A
Display medium	Nematic Liquid Crystal, FEM (Field Effect Mode)
Display system	Three-function changeover system with time, stopwatch, and time/calendar setting functions. <ul style="list-style-type: none"> • Time function: Digital display system showing hour, minute, second and day. In the time function, calendar is displayed by depressing a button. • Calendar: Digital display showing month, day and date. • Stopwatch function: 12-hour digital display system showing hour, minute, second and 1/10 second (The 1/10 second measurement is possible up to minutes.)
Additional mechanism	<ul style="list-style-type: none"> • Battery life indicator (It starts the entire display flashing when the time digits are displayed.) • Pattern segment checking system • Illuminating light
Crystal oscillator	32,768 Hz (Hz = Hertz . . . Cycles per second)
Loss/gain	Loss/gain at normal temperature range Mean monthly rate: less than 15 seconds Annual rate: less than 3 minutes
Casing diameter	φ28.9 mm
Height	7.0 mm (without battery)
Operational temperature range	-10°C ~ +60°C (14°F ~ 140°F)
Regulation system	Trimmer condenser
Battery power	Silver oxide battery SEIKO SB-BU or Maxell SR1130W Battery life is approximately two years. (If the light is used 5 times a day.) Voltage: 1.5V
IC (Integrated Circuit)	C-MOS-LS1 1 unit

2. Features

- (1) Not only has Cal. A128 the time function but the stopwatch function as well to serve wide needs of users.
- (2) The stopwatch function is able to accumulate time as long as up to 12 hours. It is ideal also for accurate time measurement of a short-distance race as the 1/10 second measurement is possible up to 20 minutes.
- (3) Having been made thinner, Cal. A128 A is handy to carry on the wrist.
- (4) Equipped with the battery life indicator, Cal. A128A lets you know the expiration of battery life in advance.

II. HOW TO USE

• Display and button operation

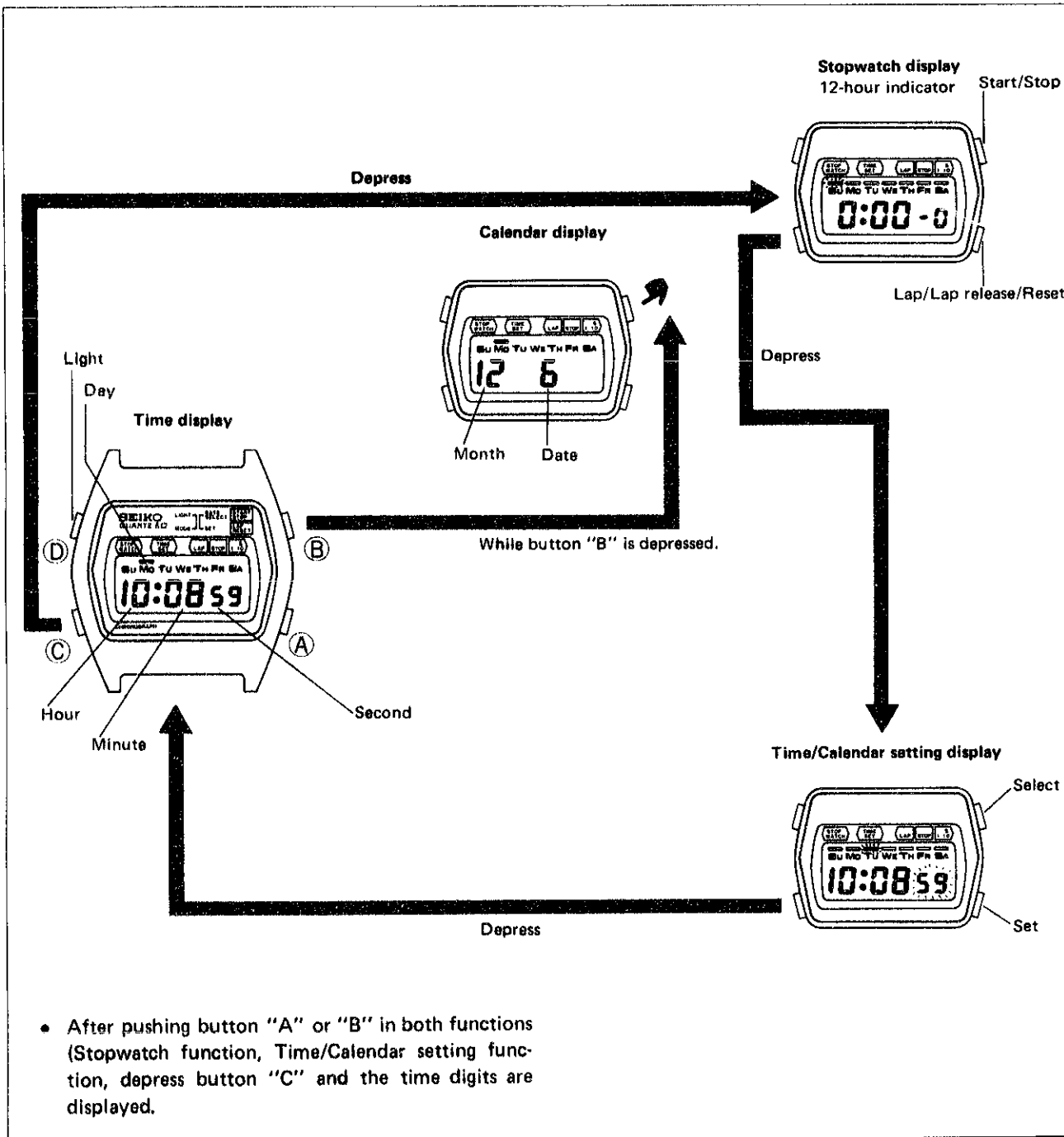

- After pushing button "A" or "B" in both functions (Stopwatch function, Time/Calendar setting function), depress button "C" and the time digits are displayed.

- Depress button "D" in all functions to activate the illuminating light.

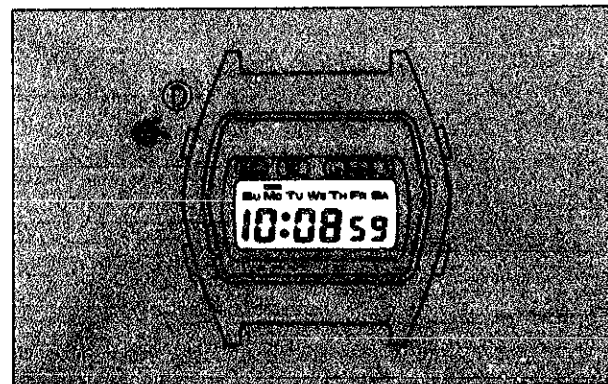

1. How to set the time and calendar

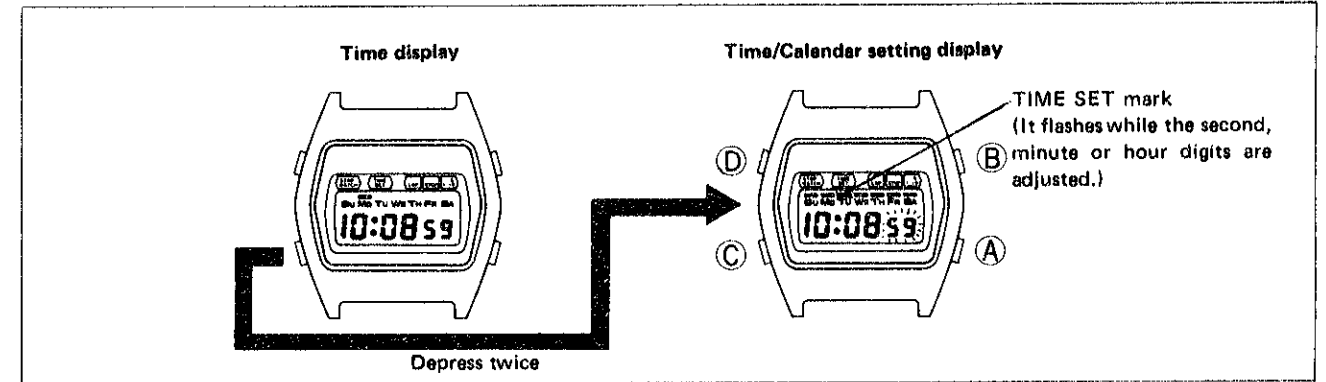

Example: The illustrations show that the indication of Monday, December 6, 10:08:42 A.M. is changed into Wednesday, August 10, 7:00:00 P.M.

Digits to be adjusted	Button operation (Select and Set)	
	SELECT (Select the digits to be adjusted.) Each depression of button "B" selects the digits (flashing) to be adjusted.	SET (Set the desired digits.) One digit (flashing) is advanced by each depression of button "A". The digits are automatically advanced by depressing and holding button "A" for one or two seconds.
Second	Depress button "C" twice to operate the time and calendar setting function.	Depress button "A" in accordance with "00" second of a time signal and the seconds are then reset to "00" and start immediately.*
Minute	Depress button "B" to select the minutes.	Depress button "A" to set the minutes to 00.
Hour	Depress button "B" to select the hours.	Depress button "A" to set the hours to 7. A.M. or P.M. mark is displayed. This will ensure the calendar changing at midnight.
Date	Depress button "B" to select the date.	Depress button "A" to set the date to 10.
Month	Depress button "B" to select the month.	Depress button "A" to set the month to 8.
Day	Depress button "B" to select the day.	Depress button "A" to set the day to 10. After the time and calendar settings are completed, depress button "C" to display the time function. Remarks: If button "B" is depressed after the day digits are set, the second digits start flashing again thus beginning the entire procedure again.

* When the seconds count any numbers from "00" to "29", the seconds are reset to "00" automatically whenever button "A" is depressed. When the seconds count any numbers from "30" to "59" and button "A" is depressed, one minute is added and the seconds are immediately reset to "00".

2. How to use as a stopwatch

(1) Preparation

Be sure to start the stopwatch device from the reset position.
(All digits must indicate "0".)

[How to reset to "0:00 00"]

1. Depress button "B" to stop the stopwatch function (STOP mark is flashing.)
2. Then depress button "A" once or twice.

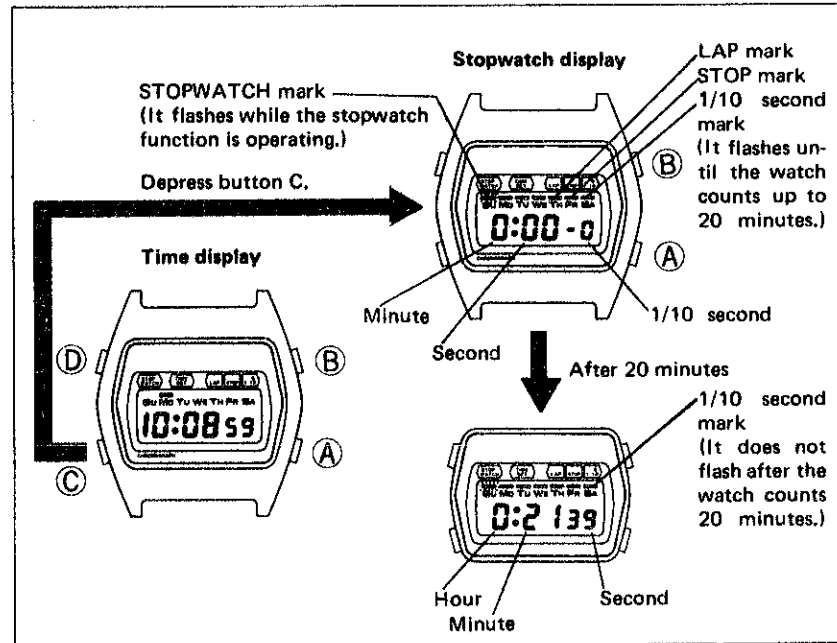

(2) Measurement

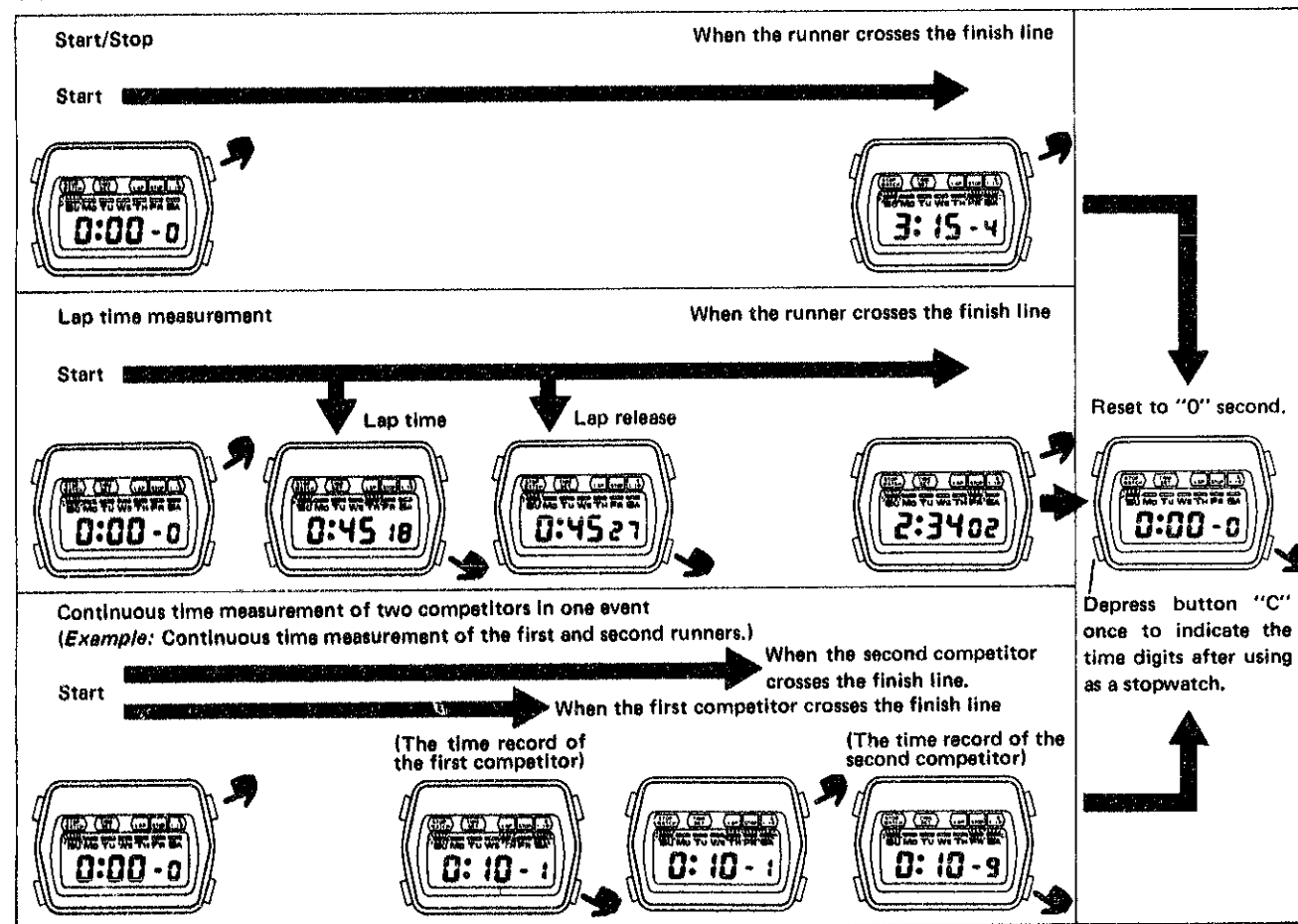

- If the stopwatch display is changed over to the time and calendar display when the LAP or LAP/STOP mark is displayed, the Lap is released when the time and calendar display is changed over to the stopwatch display again.
- The stopwatch functions and the time and calendar functions work independently. When the stopwatch functions are used for a long time, it is recommended that button "C" is depressed to indicate the time function. That prevents the button from being depressed by mistake.

III. DISASSEMBLING AND REASSEMBLING

1. Disassembling and reassembling of the case

Disassembling procedures Figs.:

①~⑦

Reassembling procedures Figs.:

⑦~①

Lubricating: ●

Silicon grease 500,000 c.s.

Normal quantity

Example: A128-5009

Glass portion

It is not necessary to disassemble the glass except when it is required to be replaced.

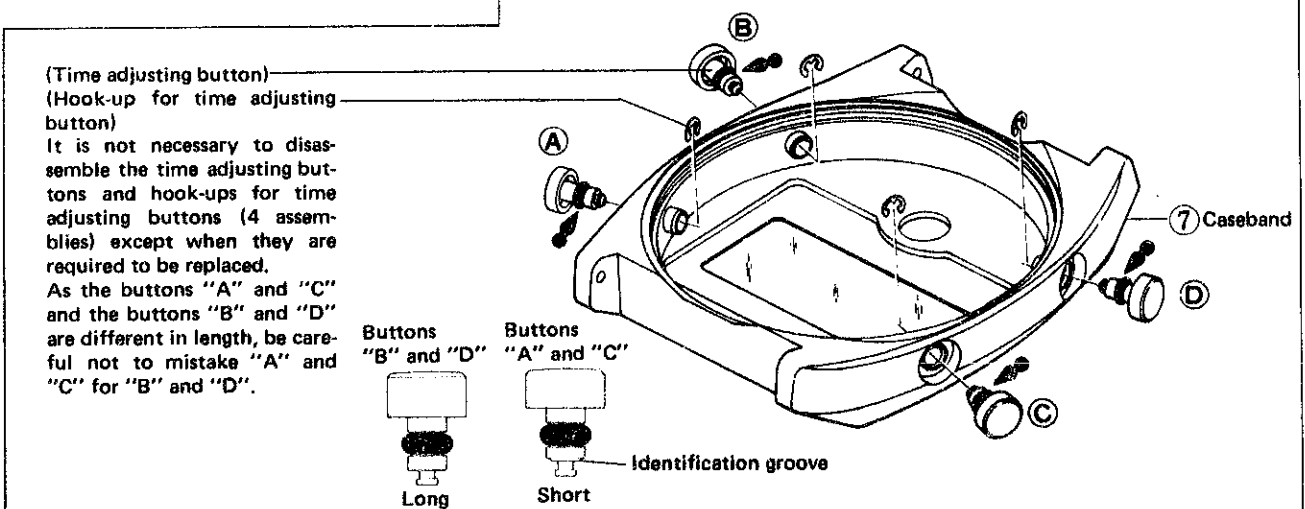
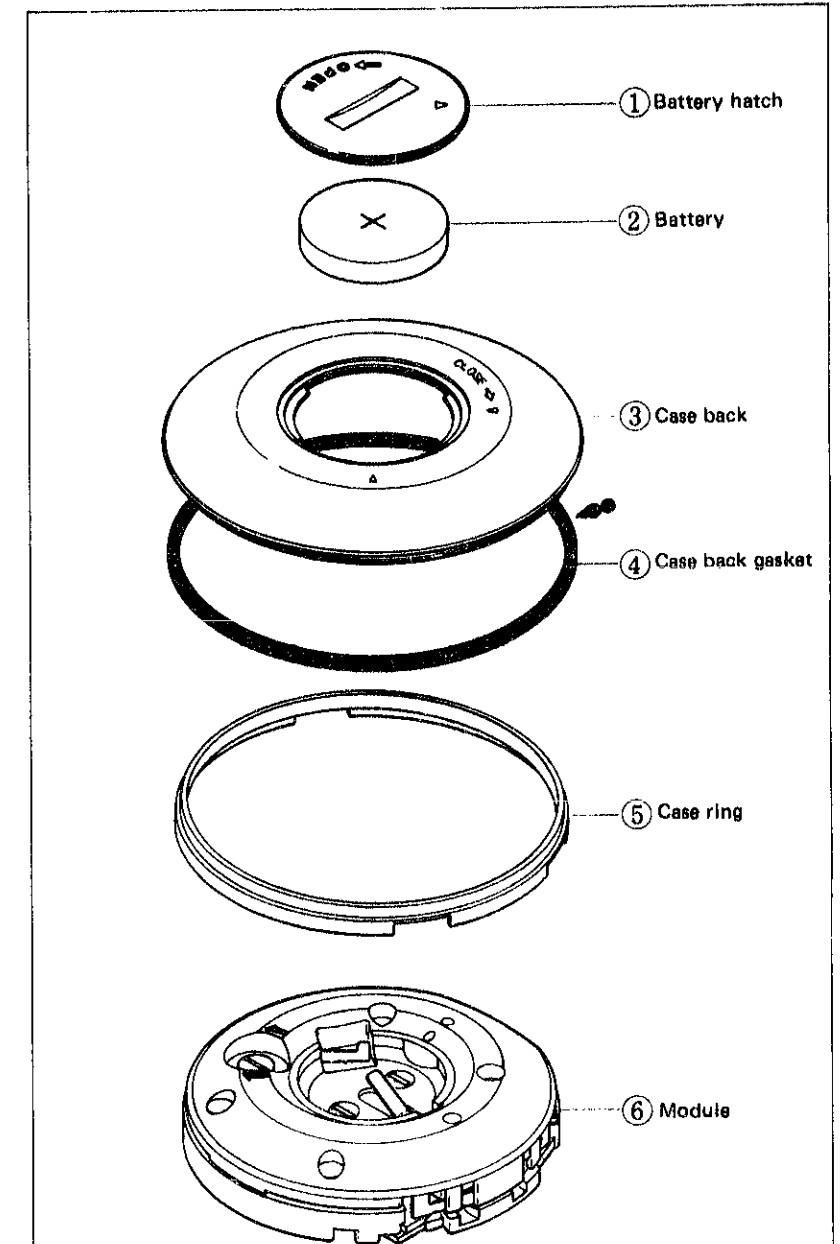
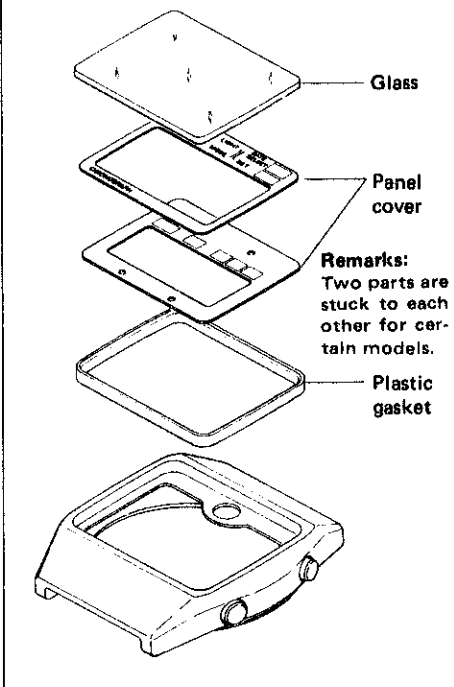

Remarks for disassembling and reassembling

③ Case back

Remarks for disassembling

- Use the case opener with a narrow tip for easy opening of the case back.

Remarks for reassembling

- Reassemble the case back by using an inserting disk whose outside diameter matches that of the case back.

Depress the brim of the case back.

Inserting disk: $\phi 29.0 \sim \phi 29.5$ mm

Supporting disk: Flat disk (S-173)

- Before reassembling, place the case in such a way that its center comes under the center of the inserting disk.

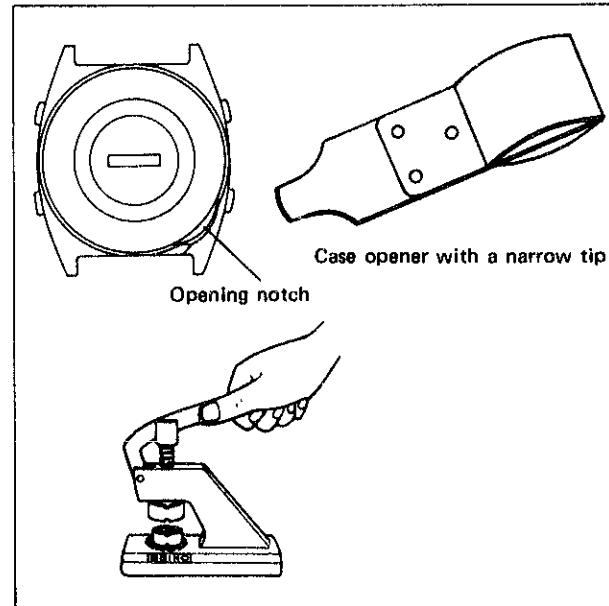

④ Case back gasket

Remarks for reassembling

- Be sure to reassemble the case back gasket firmly.
- Make sure specially that the gasket is fixed correctly at the opening notch.

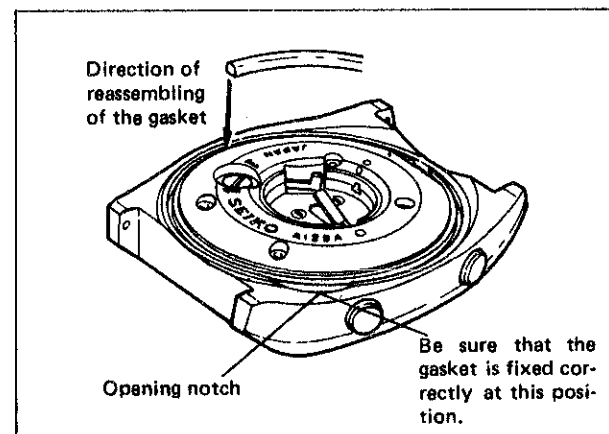

⑤ Case ring

Remarks for disassembling

- Pry up the case ring with tweezers as shown in the illustration on the right.

Remarks for reassembling

- Reassemble the case ring in such a way that the notch of the button pipes come to the button portions.
- Be careful not to depress any button before reassembling the case back.

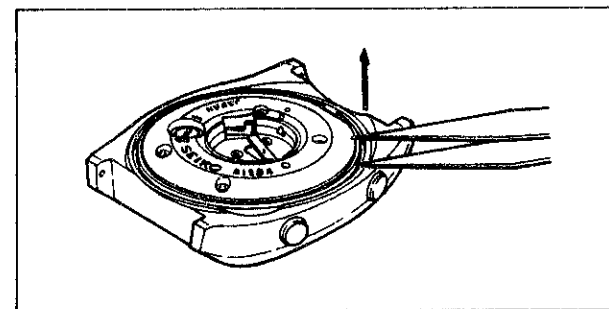

⑦ Caseband

Remarks for reassembling

- Before reassembling the module, pull out all buttons so that the switch spring does not prevent the module from being reassembled.

(Push the buttons from the inside with the tips of tweezers.)

- Be sure that the protrusion of the module is fixed in the hole for correct positioning of the module.

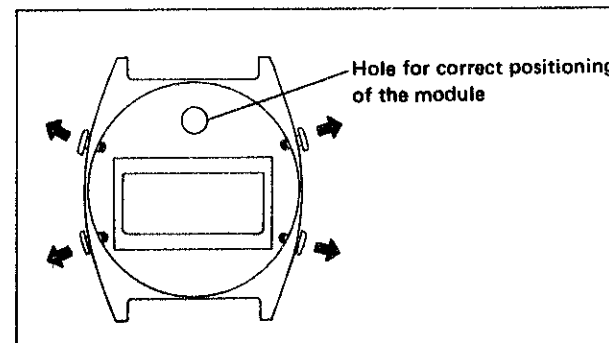

How to replace the glass

(Do not disassemble the glass except when the replacement of the glass and the panel cover is necessary.)

• **Disassembling of the glass**

- Use the tightening tool S-220 to disassemble the glass.
Inserting disk: S-162
Supporting disk: $\phi 34.0 \sim \phi 35.0$ mm
- Place a vinyl sheet between the glass and the supporting disk as shown in the illustration.
- With the Inserting disk (S-162), push only the glass for disassembling. Do not push the panel cover.

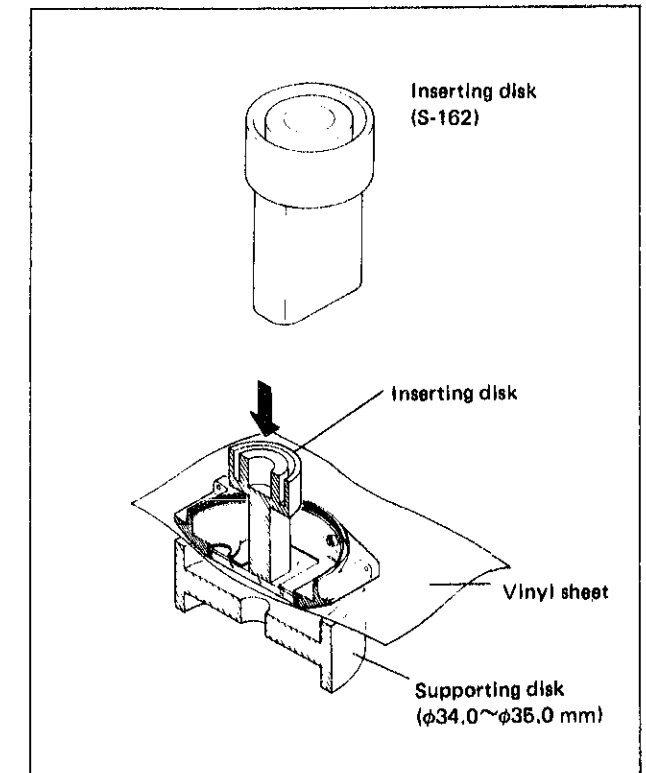

• **Reassembling of the glass**

- Set the plastic gasket.
 - Be sure to replace the plastic gasket with a new one.
 - Be careful not to mistake the upper side for the lower side.
- Reassemble the panel cover.
 - Be sure to set the back side of the panel cover in position of the caseband firmly.
 - Make sure that the space between the caseband and the edge of the panel cover is uniform in width.
- Place the glass.
 - Be careful not to mistake the upper side for the lower side.
- Fix the glass (use S-220)
 - Inserting disk: Plastic supporting disk (S-173)
 - Supporting disk: $\phi 26.0$ mm

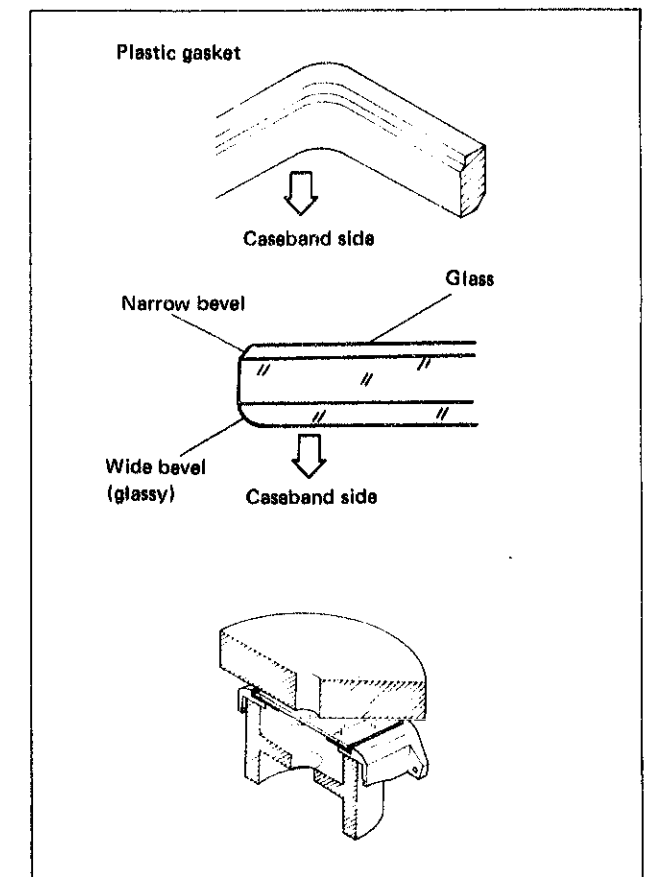

2. Disassembling and reassembling of the module

Disassembling procedures Figs.:

①~⑨

Reassembling procedures Figs.:

⑨~①

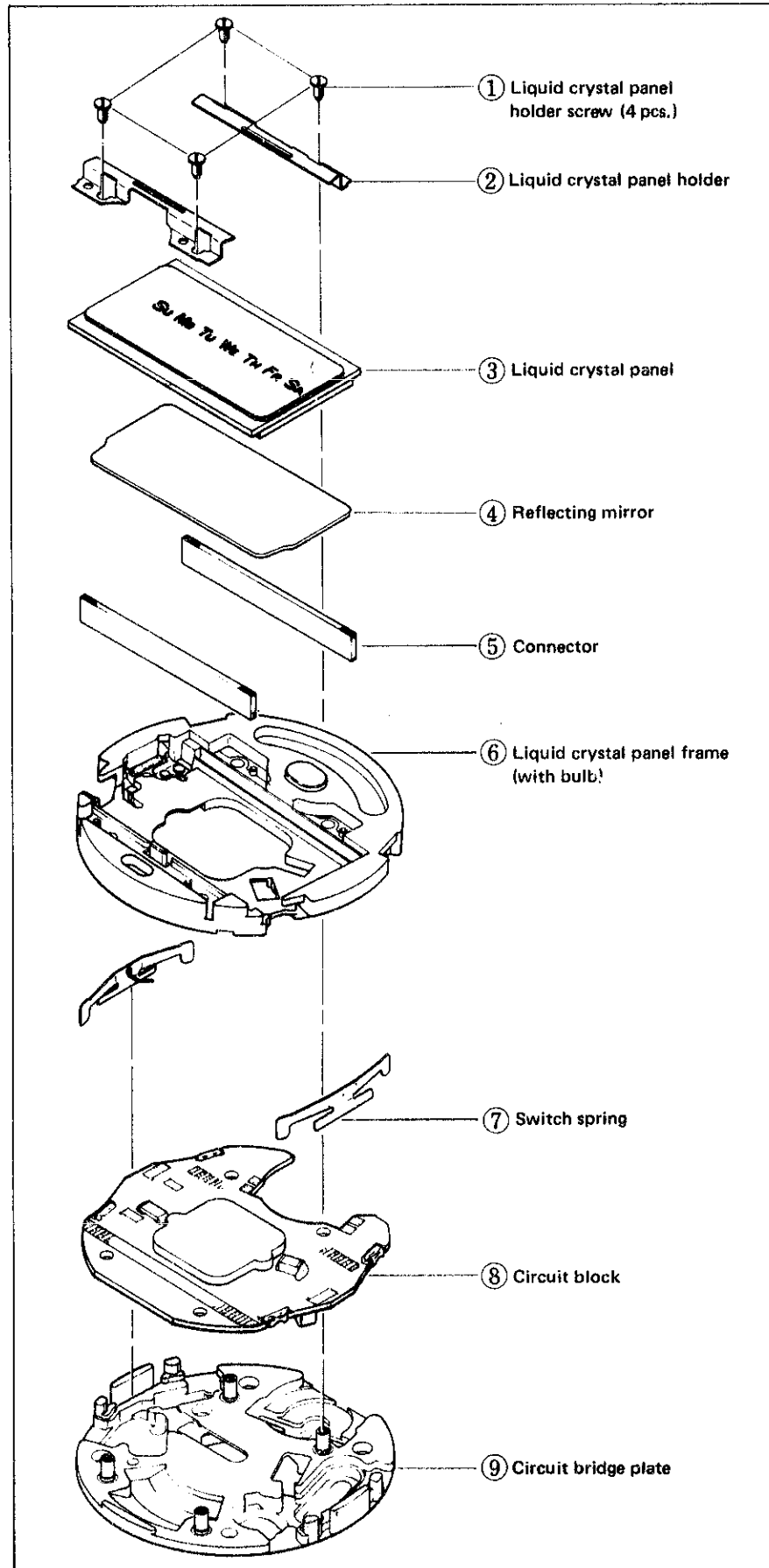

Remarks for disassembling and reassembling

④ Reflecting mirror

Remarks for disassembling and reassembling

- Be careful not to scratch or contaminate the reflecting mirror.

⑥ Connector

Remarks for disassembling

- The connectors may be disassembled together with the liquid crystal panel.

Remarks for disassembling and reassembling

- There is no difference between the upper side and the lower side.
- Be careful not to scratch the connectors with tweezers.

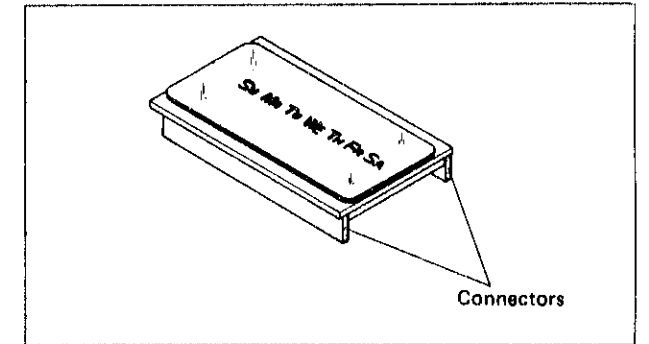

⑦ Switch spring

Remarks for reassembling

- Set the switch spring vertically in its position.

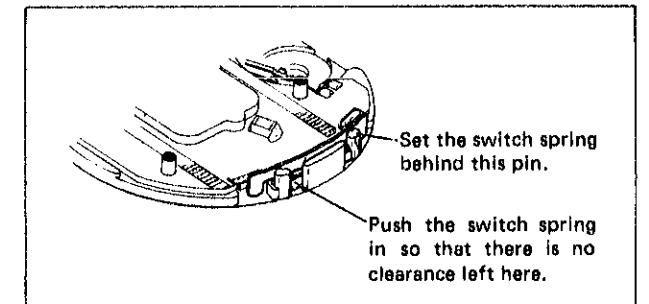

⑧ Circuit block

Remarks for disassembling and reassembling

- Be careful not to touch the electronic parts except when necessary.

3. Cleaning

1) HOW TO CLEAN

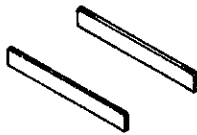
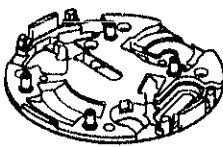
Name of parts	Cleaning	Drying	Solution	Remarks
Connector 	Rinse	Cool air	Alcohol	Be sure to reassemble after drying thoroughly. Do not use benzine or trichloroethylene.
Circuit bridge plate 	Rinse or clean with a soft brush.	Cool air	Alcohol	Do not use a solution other than alcohol.
Other parts (Switch spring, liquid crystal panel holder, liquid crystal panel holder screw).	Clean or rinse with a cleaner or a brush.	Cool or hot air	Trichloroethylene, benzine or alcohol	

2) PARTS THAT MUST NOT BE CLEANED

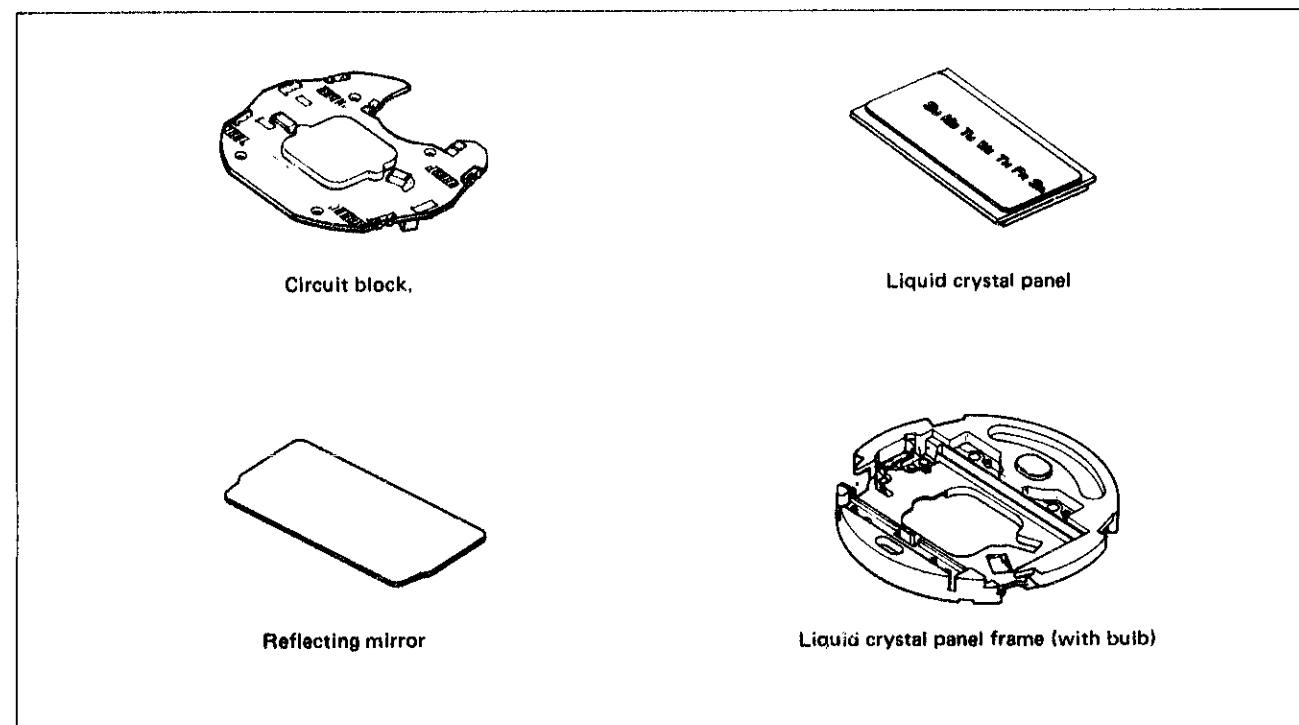

- Wipe dust and lint off with a soft brush.
- Wipe the electrodes of the liquid crystal panel only with a cloth moistened with benzine or alcohol.

IV. CHECKING AND ADJUSTMENT



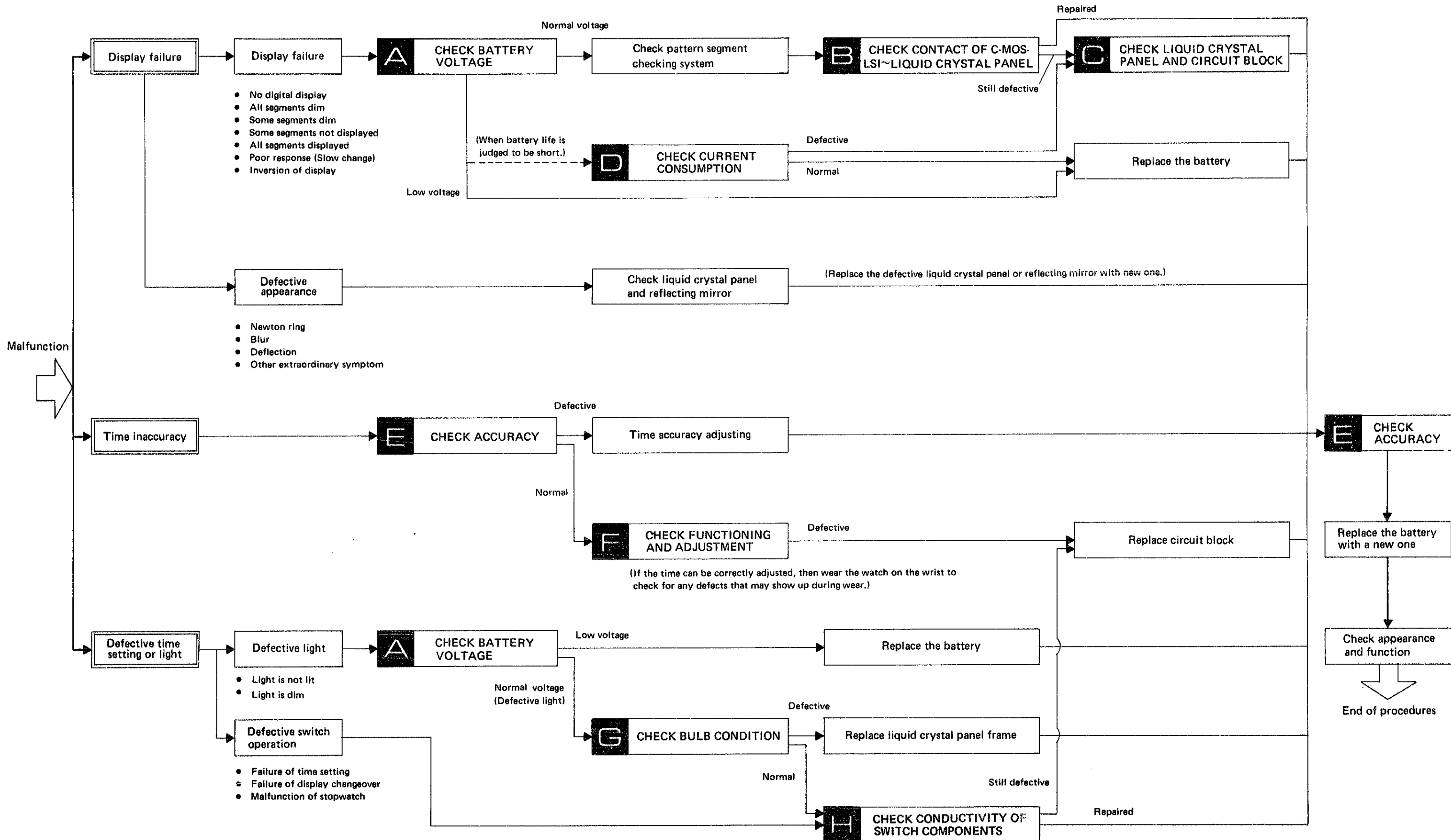

Be sure to use the Static electricity protector (S-830) when handling the module.

1. Guide table for checking and adjustment

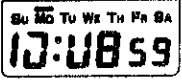

2. Malfunction and checking points

- Check in the numerical order.
- Refer to "Guide table for checking and adjustment" on page 11.

FAULTY SYMPTOMS		CHECKING POINTS								
		A		B	C			F	G	H
		Battery voltage	Check pattern segment checking system	Contact of C-MOS-LS1~ liquid crystal panel	Liquid crystal panel	Circuit block	Time accuracy adjusting	Functioning and adjustment	Bulb	Switch components
DISPLAY FAILURE	No digital display, dim digital display or extremely slow response.	①		②	③	④				
	All segments are lighted.			①	②	③				
	Some segments of the digital figures are not lighted.  Inversion of display 			①	②	③	④			
	(Deflection) Some or all of one segment show different contrast depending on the direction of view.  (Poor appearance) Some portions of the liquid crystal panel will have air bubbles or iridescent view. 					①				
TIME INACCURACY	Gain or loss tested by Quartz Tester.						①			
	Though Quartz Tester indicates the normal figures, the watch gains or loses when it is worn on the wrist.							①		
DEFECTIVE TIME AND CALENDAR SETTING OR LIGHT	Light is not lit or light is lit but dims soon.	①							②	③
	Failure of time setting, display changeover or malfunction of stopwatch.									①

3. Relationship between the segment (Liquid Crystal Panel Electrode) and the C-MOS-LSI output terminal.

A complete knowledge of how the segment (Liquid Crystal Panel Electrode) works with the C-MOS-LSI output terminal will provide the correct procedures for checking and adjustment.

● **Designation of segment**

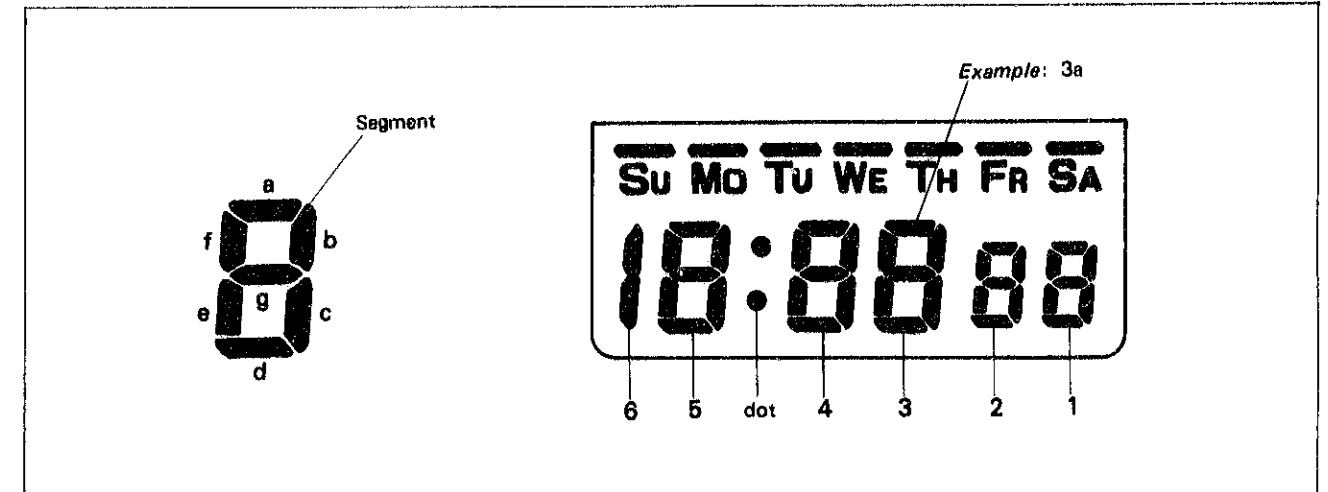

● **Relationship between the segment and the C-MOS-LSI output terminal**

The liquid crystal panel electrode is connected electrically with each segment which forms a digital figure as shown in the illustration of the panel pattern below. (The panel pattern can be seen if the panel is slightly tilted and looked at in an angular position.)

Also, the liquid crystal panel electrode is connected electrically with the C-MOS-LSI output terminal by the connector.

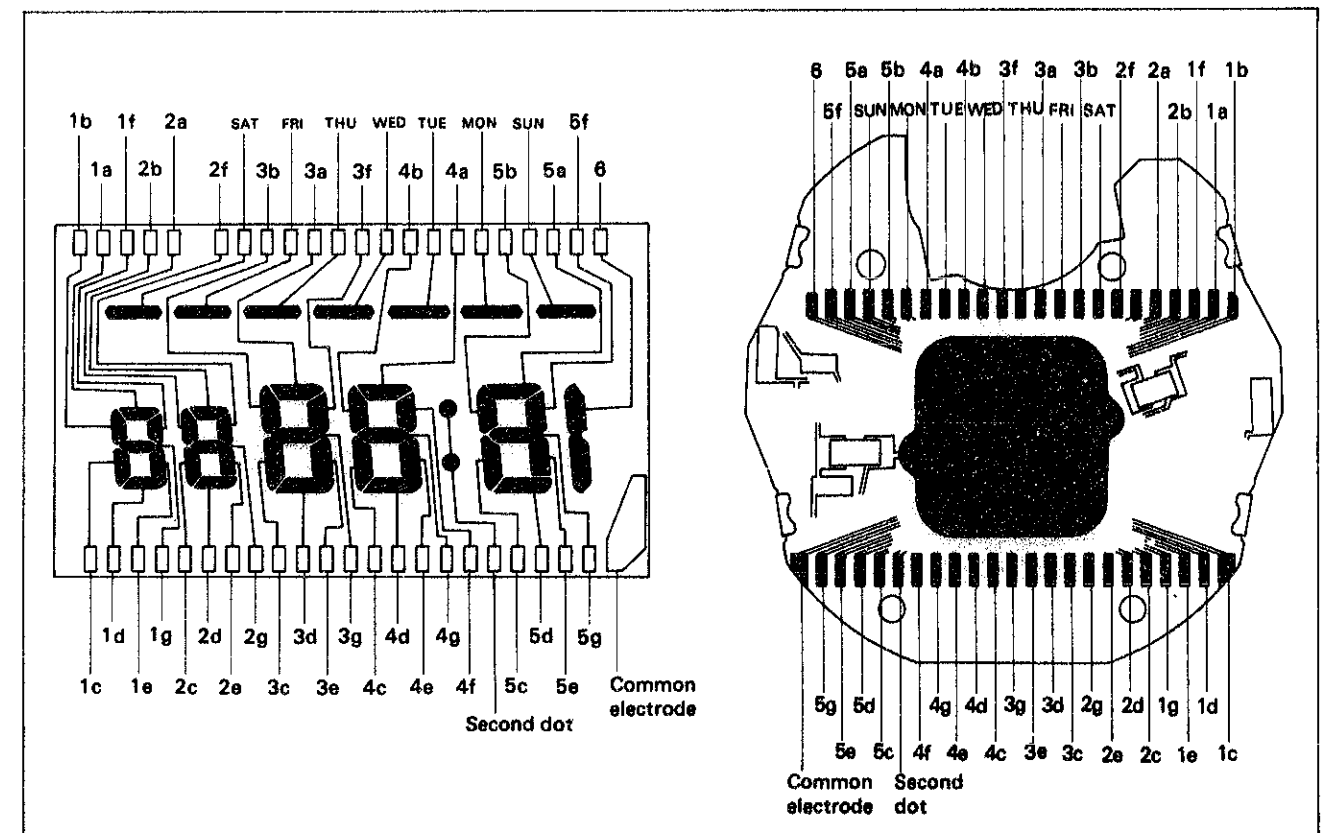

Note: Poor conductivity of the common electrode causes the lighting of all segments or inversion of the display.

4. Procedures for checking and adjustment

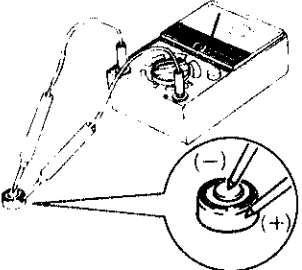
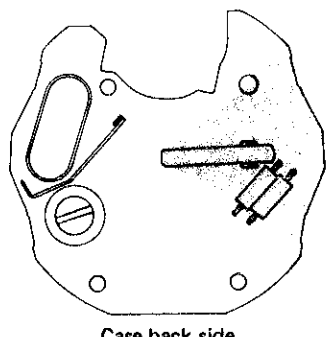
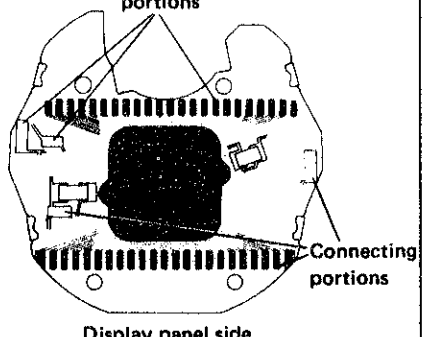
	Procedure	Result and repair
CHECK BATTERY VOLTAGE	<p>Use the following procedures to check battery voltage.</p> <p>(1) Set up the volt-ohm-meter. Range to be used: DC3V</p> <p>(2) Measuring Probe Red (+) . . . Battery surface (+) Probe Black (-) . . . Battery surface (-)</p>  <p>When there is battery electrolyte leakage, refer to "HOW TO CHECK BATTERY ELECTROLYTE LEAKAGE AND REPAIR" below for repairing.</p>	<p>More than 1.5V . . . Normal Less than 1.5V . . . Defective</p>
HOW TO CHECK BATTERY ELECTROLYTE LEAKAGE AND REPAIR	<p>(1) Remove the module from the case.</p> <p>(2) Disassemble the module.</p> <p>(3) Wipe off battery electrolyte on the circuit block.</p> <p>1. Wipe off battery electrolyte with a cloth moistened with distilled water. If distilled water is not available, use tap water.</p> <p>Note:</p> <ul style="list-style-type: none"> Do not use a cloth which gives off lint such as gauze, flannel, etc. Do not expose the trimmer condenser to water or alcohol, and if it is exposed, there may be a change in its condenser capacity and eventually in the time accuracy. When the circuit block is cleaned, be sure to clean the shaded portions shown on the right and the connecting portions. <p>2. Wipe the shaded portions and the connecting portions again with a cloth moistened with alcohol. (If the cleaned portions remain wet with water, they will corrode with rust.)</p> <p>3. Dry with cool air by using a dryer.</p> <p>(4) Clean the other parts (circuit bridge plate, switch spring, etc.).</p> <p>1. Wipe off battery electrolyte on the other parts with a soft brush moistened with distilled water. (If distilled water is not available, use normal tap water.)</p> <p>2. Rinse with alcohol.</p> <p>3. Dry with cool air by using a dryer.</p> <p>(5) Reassemble the module. Replace the battery with a new one.</p> <p>(6) Check to see if the time and calendar function, the stopwatch function, the calendar function and the current consumption are normal.</p>  <p>Case back side</p>  <p>Display panel side</p>	

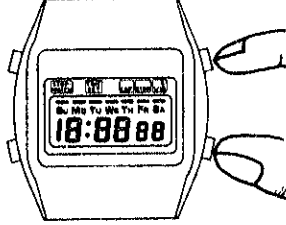
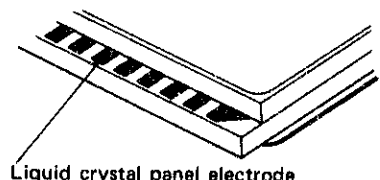
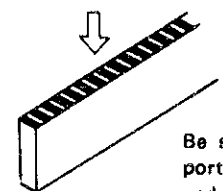
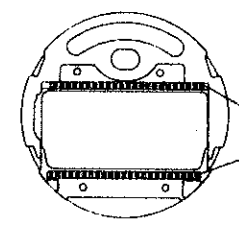
	Procedure	Result and repair
CHECK PATTERN SEGMENT CHECKING SYSTEM	<p>If some segments are dead or dim, change the function into the time function. Then depress buttons "A" and "B" together to find the defective segments. (If there is no defective segment, all segments will be displayed.)</p> 	<p>Proceed to 13</p>
CHECK CONTACT OF C-MOS-LSI ~ LIQUID CRYSTAL PANEL	<p>After removing the liquid crystal panel, check for poor conductivity of the liquid crystal panel, connector and C-MOS-LSI output terminal whose segments are found to be defective in "CHECK PATTERN SEGMENT CHECKING SYSTEM". (Refer to "Relationship between the segment and the C-MOS-LSI output terminal" on page 13.) Use a microscope for checking.</p> <p>(1) Check for dust, lint and other contamination on the liquid crystal panel electrode.</p>  <p>Liquid crystal panel electrode</p> <p>(2) Check for any contamination, scratch, crack and break of the connector.</p>  <p>Be sure to check the connecting portion of the liquid crystal panel and the circuit block carefully.</p> <p>(3) Check for dust, lint and other contamination on the output terminal of the circuit block.</p>  <p>Output terminal of the circuit block.</p>	<p>Uncontaminated: Normal Proceed to 13 (2).</p> <p>Contaminated: Defective Wipe off any foreign matter.</p> <p>No contamination, scratch, crack or break: Normal Proceed to 13 (3).</p> <p>Contaminated: Defective Cleaning (See page 10.)</p> <p>Scratched, cracked or broken: Defective Replace the connector with a new one.</p> <p>Uncontaminated: Normal Proceed to 13.</p> <p>Contaminated: Defective Wipe off any foreign matter.</p>

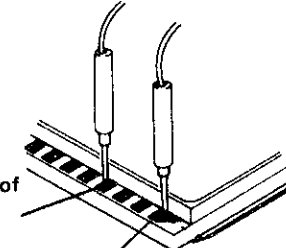
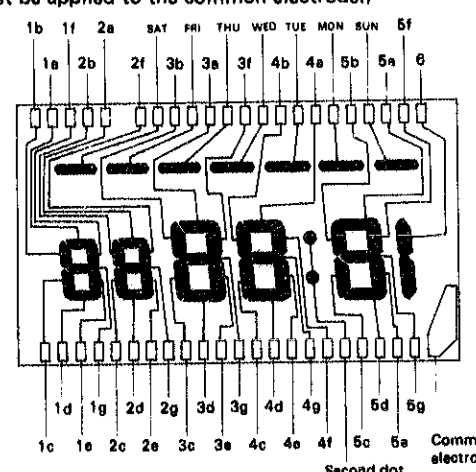
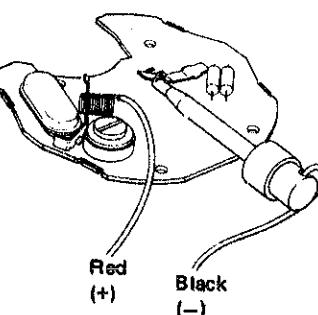
Procedure	Result and repair
<p>Check to see if the liquid crystal panel and the circuit block function correctly. (Refer to "Relationship between the segment and the C-MOS-LSI output terminal" on page 13).</p> <p>(1) Check liquid crystal panel</p> <ol style="list-style-type: none"> Set up the volt-ohm-meter. Range to be used: OHMS R x 1 ~ R x 1K <p><i>Note:</i></p> <ul style="list-style-type: none"> Any range will do if more than 3V is applied to the terminal of the volt-ohm-meter. If the output voltage of the volt-ohm-meter is less than 3V in measuring, all segments may not be lit. If any segment does not light, change the range to the one (R x 10K) which is higher in resistance than R x 1K. <p>2. Remove the liquid crystal panel from the module and turn it upside down.</p> <p>3. Measuring (Check to see if the corresponding segment lights up.)</p> <p><i>Note:</i> Either red or black probe will do.</p>  <p>Electrode of defective segment</p> <p>Common electrode (Either red or black probe must be applied to the common electrode.)</p>  <p>1b 1f 2a SAT FRI THU WED TUE MON SUN 5f 1a 2b 2f 3b 3a 3f 4b 4a 5b 5a G 1d 1g 2d 2g 3d 3g 4d 4g 5d 5g 1c 1e 2c 2e 3c 3e 4c 4e 5c 5e Common electrode Second dot</p> <p>(2) Check the circuit block output voltage.</p> <ol style="list-style-type: none"> Set up the volt-ohm-meter. Range to be used: DC3V Attach the current supplier (S-833) to the circuit block. Spring (+): Plus terminal of battery connection. Clip (-): Battery connection  <p>Red (+) Black (-)</p>	<p>Lights up: Normal Proceed to (2).</p> <p>Does not light up: Defective Replace the liquid crystal panel with a new one.</p>

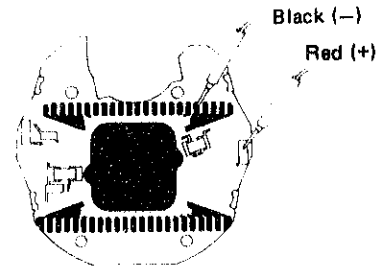
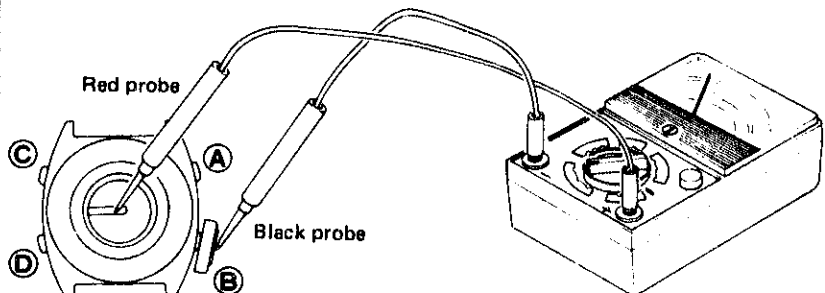
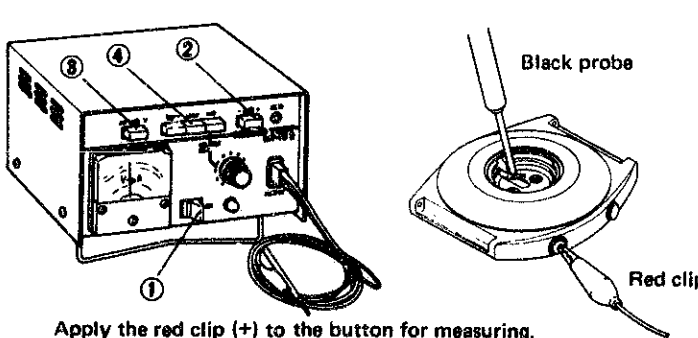
Procedure	Result and repair												
<p>3. Measuring</p> <p>Probe Red (+): Connecting portions of the switch spring of the circuit block.</p> <p>Probe Black (-): Each portion of the output terminals of the C-MOS-LSI. (If some displays are defective, apply to the corresponding output terminals of the C-MOS-LSI.)</p>  <p>Black (-) Red (+)</p>	<p>More than 0.8V: Normal (All the terminals must be more than this range of voltage.) Return to (1).</p> <p>Less than 0.8V: Defective Replace the circuit block with a new one and check to see if it functions correctly.</p>												
<p>Check to see if the current consumption is normal. (Can be checked no matter which function the watch may be performing.)</p> <ul style="list-style-type: none"> Volt-ohm-meter Range to be used: DC 12μA or 0.03mA* Probe Red (+): Battery connection Probe Black (-): Battery surface (-)  <p>Red probe Black probe</p> <p>Touch the battery surface (+) to the button (except the buttons "C" and "D") for measuring.</p> <ul style="list-style-type: none"> Micro Test MT-10II Set up the Micro Test MT-10II* <table border="0"> <tr> <td>① Power switch</td> <td>: ON</td> <td>Be careful not to depress the button while measuring.</td> </tr> <tr> <td>② Polarity changeover button</td> <td>: +</td> <td></td> </tr> <tr> <td>③ Current consumption/Voltage indication button</td> <td>: μA</td> <td></td> </tr> <tr> <td>④ Voltage selection button</td> <td>: 1.55V</td> <td></td> </tr> </table> <p>Probe Black (-): Battery connection Clip Red (+): Button (except the buttons "C" and "D")</p>  <p>Black probe Red clip</p> <p>Apply the red clip (+) to the button for measuring. Be careful not to depress the button while measuring.</p>	① Power switch	: ON	Be careful not to depress the button while measuring.	② Polarity changeover button	: +		③ Current consumption/Voltage indication button	: μ A		④ Voltage selection button	: 1.55V		<p>Less than 3.5μA: Normal Replace the battery.</p> <p>More than 3.5μA: Defective Proceed to (1).</p> <p>* <i>Note:</i></p> <ul style="list-style-type: none"> If the pointer of the volt-ohm-meter swings over the maximum value when DC12 μA or 0.03 mA is used, change the range to a greater one where the pointer does not run over the maximum value while applying the probes to the respective portions. Then, after two or three seconds, return the range to DC 12μA or 0.03 mA again for measuring. If the pointer of the Micro Test MT-10 II swings over the maximum value while the current consumption is measured, depress the Current consumption/Voltage indication button ③ so that it is released to indicate the voltage (mV) while the black probe and the red clip are applied. Then, after two or three seconds, depress the Current consumption/Voltage indication button again so that it holds the pushed-in position (μA) to indicate the current consumption for measuring.
① Power switch	: ON	Be careful not to depress the button while measuring.											
② Polarity changeover button	: +												
③ Current consumption/Voltage indication button	: μ A												
④ Voltage selection button	: 1.55V												

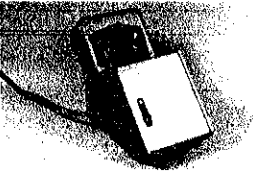
	Procedure	Result and repair
CHECK ACCURACY	<p>Check gain and loss of time.</p> <ol style="list-style-type: none"> 1. Set up the Quartz Tester. As there are several types of Quartz Testers, refer to the respective instruction manual. 2. Measuring 	<p>If the watch tends to gain or lose, proceed to Time accuracy adjusting. Time accuracy is adjusted by turning the trimmer condenser.</p>
CHECK FUNCTIONING AND ADJUSTMENT	<p>See "HOW TO USE" on page 2 to check the functioning and adjustment.</p> <ol style="list-style-type: none"> 1. Check the stopwatch function. Check to see if "start", "stop", "lap", "lap release" and "reset" function correctly. 2. Check the time and calendar setting function. Set the time and calendar digits more than one cycle for each unit and check to see if each digit is advancing correctly. 	<p>Function correctly and can be adjusted: Normal Wear the watch on the wrist to check time accuracy.</p> <p>Does not function correctly or cannot be adjusted: Defective Proceed to Replace circuit block.</p>

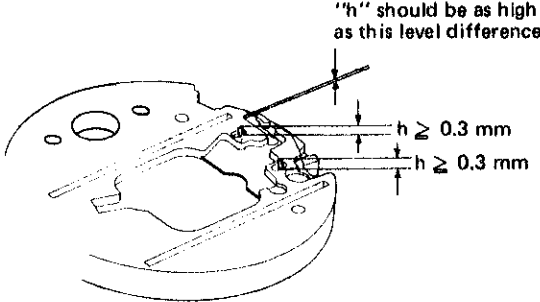
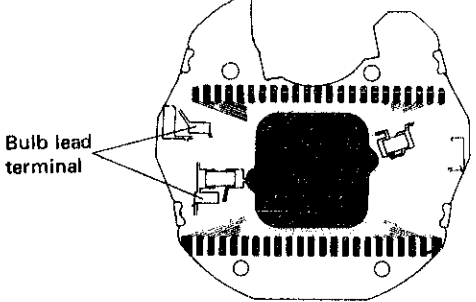
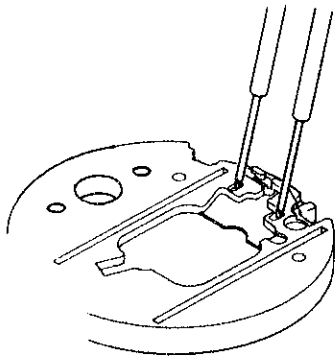
	Procedure	Result and repair
CHECK BULB CONDITION	<p>(1) Check to see if the bulb lead terminals touch the lead terminal of the circuit block.</p> <ol style="list-style-type: none"> 1. Check to see if the two bulb lead terminals protrude by more than 0.3 mm from the back side of the panel frame. And check for any dust, lint and other contamination of the bulb lead terminal.  <ol style="list-style-type: none"> 2. Check for any contamination on the bulb lead terminal of the circuit block.  <p>(2) Check to see if there is a broken filament in the bulb and if there is any break in the welded portion of the bulb lead terminal.</p> <ol style="list-style-type: none"> 1. Set up the volt-ohm-meter. Range to be used: OHMS R x 1 2. Measuring Apply the two probes of the volt-ohm-meter to the bulb lead terminals as shown in the illustration. <i>Note:</i> Either red or black probe will do. 	<p>Protrudes by more than 0.3 mm: Normal Protrudes by less than 0.3 mm: Defective Pull out by using tweezers.</p> <p>No dust, lint or uncontaminated: Normal Proceed to (2).</p> <p>Dust, lint or contaminated: Defective Wipe off any foreign matter.</p> <p>Bulb lights up: Normal Proceed to (1).</p> <p>Bulb does not light up: Defective Replace liquid crystal panel frame (with bulb).</p>

Procedure

Check to see if the switch spring functions correctly.

(1) Check to see if the switch springs (four arrow-marked portions shown in the illustration below) function correctly when they are pushed in.

1. Check to see if the four arrow-marked springs touch the switch terminals of the circuit block when they are pushed in by the tips of tweezers and if they do not touch the switch terminals of the circuit block when released.

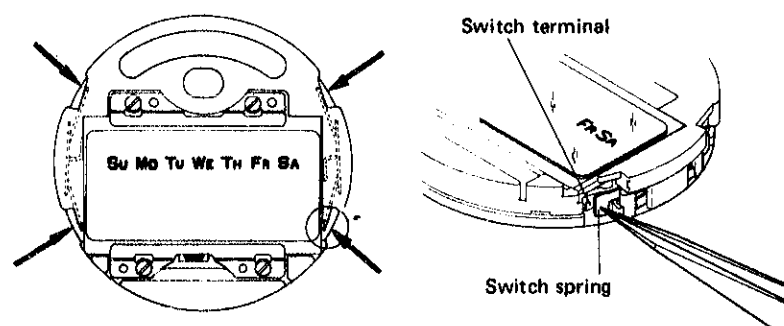

2. Check for dust, lint and other contamination on the contacting portions.

(2) Check to see if the lead terminal of the switch spring touches the lead terminal of the circuit block.

1. Check to see if the two arrow-marked portions touch correctly when the panel frame is disassembled.

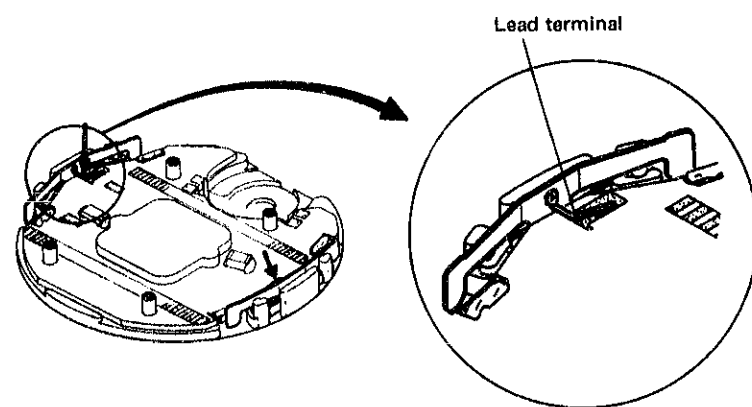

2. Check for dust, lint and other contamination on the contacting portions.

When there is battery electrolyte leakage, refer to "HOW TO CHECK BATTERY ELECTROLYTE LEAKAGE AND REPAIR" on page 14 for repairing.

Result and repair

Functions correctly:

Normal

Does not function correctly:

Defective

If the switch springs do not function correctly after the switch springs are adjusted, replace the switch springs with new ones.

No dust, lint for uncontaminated:

Normal

Proceed to I (2).

Dust, lint or contaminated:

Defective

Wipe off any foreign matter.

Touch:

Normal

Do not touch:

Defective

Adjust by using tweezers so that the lead terminal of the panel frame touches the lead terminal.

No dust, lint or uncontaminated:

Normal

Replace circuit block.

Dust, lint or contaminated:

Defective

Wipe off any foreign matter.

All procedures of Disassembling, Reassembling, Checking and Adjustment are completed.